

 KingCamp

去户外 学会爱  
LEARN TO LOVE OUTDOORS

全球 38 个 国家 家庭 户外 选择



**2017-2018**  
*Outdoor Equipment*

# ABOUT KINGCAMP

## 品牌介绍

KingCamp, 家庭户外的倡导者, 户外自驾露营装备知名品牌。

自 2002 年创立以来, KingCamp 始终致力于向全世界推广户外生活方式, 以其“舒适、轻松、分享、环保”的户外理念、独特的设计、专业的品质和优质的服务赢得全世界户外爱好者的青睐, 产品畅销全球 30 多个国家。

KingCamp 的产品涵盖露营、徒步、旅行、休闲四个系列近千个品种。无论从产品设计、面料选择还是质量把控上, KingCamp 品牌均严格执行国内外先进标准。

KingCamp 不仅是一个品牌, 更代表一种健康、先进的生活方式, 引导人们轻松舒适地享受户外, 贴近自然。

#### FOUNDER:

The KingCamp Brand was founded by Shu Guoking from China who in 1993 trekked across China into Europe. During his travels he encountered the freedom and beauty of the outdoors everywhere he went. These experiences led him to make a life changing decision. He would return to his native home to begin the process of building a company that would make accessing the experience of the great outdoors globally easy and affordable for all without compromising quality or performance.

#### MISSION STATEMENT:

Our mission is to assist is to help people live in harmony with nature; Outdoor is not only a personal challenge of yourself or challenge of nature, it is more lifestyle with your family: love your self, love your family, love your friends, love nature, keep harmony with nature, keep hamony with the people around you, this is life.

Shu developed the corporate motto of: "LEARN TO LOVE OUTDOORS" as a result of his experiences.

#### CORPORATE TIMELINES:

Started from 1993, Shu co-operate closely with famous outdoor brands all the world .

Shu Guoking founded the KingCamp brand in 2002. Since then the company has become the global leader in the manufacturing and distribution of outdoor gear in more than 38 countries worldwide.

True to Shu's original goals, KingCamp has been providing excellent products aimed at satisfying the needs of our clients and their relationship with nature.

KingCamp is not only a brand, but also a concept which is reflected in the design and function of products to serve the comfort, needs, and security of our clients while respecting the environment.

KingCamp offers a wide range of products covering outdoor activities of camping, hiking, travel, and leisure. Each product design is based on the specific requirements of our clients and the comments from our testers who use the products in extreme outdoor conditions. KingCamp incorporates the most advanced technology in machinery, manufacturing techniques and materials to produce products that are subject to our strictest quality control. We partner with famous European designers to guarantee our products are always in the world class level and in the same step of design trends in outdoor developments worldwide.

In 2004 the KingCamp Brand went through the process to obtain global registration and began to enter global markets with its innovative products.

In 2008 KingCamp Brand supplies and markets in 38 countries around the world. Also KingCamp establishes 500 sales outlets in 80 cities in China.

The 2010 KingCamp Brand begins to sell its products into the United States, France, Russia and other 38 countries. Their high quality products have been internationally recognized for the best performance to price ratio in the "Family Camping" category.

#### CORPORATE VALUES:

Brand Positioning: KingCamp is Family Camping whether it's hiking – trekking or car camping.

KingCamp is not only a brand, but also represent a healthy state-of-the-art way of life, and guide people to easily and comfortably enjoy the outdoors close to nature.

\* 图片仅供参考，产品请以实物为准  
Pictures for reference only, goods in kind prevail!



FANTASY 系列

12-16



彩虹条系列 RAINBOW

17-19

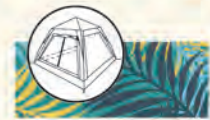

棕榈系列 PALM RANGE

20-23



帐篷系列 TENT RANGE

24-51



睡袋系列 SLEEPING BAGS RANGE

52-68



垫子系列 MAT RANGE

69-80



背包系列 BACKPACK RANGE

81-88



户外家具 OUTDOOR FURNITURE

89-118



野餐系列 PICNIC RANGE

119-128



配件系列 ACCESSORIES RANGE

129-159

# CONTENTS

# 目录



## 露营半山林海

### CAMPING IN THE WOODLANDS HALFWAY UP A HILL

露营至半夜，星光变得黯淡，天气预报说今晚有雨，果然。打开车灯，将帐篷门厅掩好，不大一会儿，风亦来，雨亦来，听半山林海微微呼啸，如置身世外。

The weather forecast said it would rain tonight, and how true it was. The stars were not shining very brightly. We turned on the lamp, fastened the door of the tent closed, and soon the rain and wind appeared. We entered a different world where we listened to the wind bluster in the woodlands.

KT3064 WAKAYA6



### 相关推荐

Related recommendation

#### 露营 Camping

- KT3064 Wakaya 6 豪华六人帐
- KM3583 Comfort Plus 舒适自充垫
- KM3544 Comfort Deluxe 豪华自充垫
- KS3208 Mountain 320 单人妈咪睡袋
- KS3205 Rremium 350 单人信封睡袋
- KA4921A Detachable Camping Light 可拆分营地灯
- KC3806A ARMYMAN CAMPING BED 行军床
- KC3039 HARD CAMPING COT L 大号铁管行军床
- KG3762 CANVAS HAMMOCK 木棍帆布吊床

#### 烧烤 BBQ

- KC3942 MULTIFUNCTIONAL BAMBOO COOKING TABLE 多功能竹面组合烧烤台
- KC3953 4-FOLDING BAMBOO TABLE L 大号四折竹面桌
- KG4704 PICNIC BLANKET 摇粒绒野餐垫
- KP3912 Climber III 五人硬质氧化套锅
- KG3794 Cooler Box 43L 43L 保温箱



## 请在我的左右 STAY WITH ME

在户外与你相识相知，蓝天白云车和帐篷都是我们的见证。  
有一句话我想对你说，请一直在我的左右，  
像空气一样，像户外一样。

We met each other outdoors. The blue sky, white clouds,  
the car and the tent are all proof of our meeting.  
I want to ask you to "stay with me please,  
just like the air and the outdoors".

KT3069 ROMA 4



### 相关推荐

*Related recommendation*

#### 露营 Camping

- KT3069 Roma 4 豪华四人帐
- KM3084 COMFORT DOUBLE 豪华双人充气垫
- KM3594 COMFORT DOUBLE 双人充气垫 (附枕)
- KS3202 ACTIVE 250 单人睡袋
- KS3204 CAMPER 250 单人睡袋

#### 烧烤 BBQ

- KC3939 ULTRALIGHT CHAIR 经典超轻椅
- KC8005 FOLDING BED 速开折叠床
- KC3942 MULTIFUNCTIONAL BAMBOO 多功能竹面组合烧烤台
- KG2725 PORTABLE GRILL 不锈钢便携烤炉
- KP3912 Climber III 五人硬质氧化套锅
- KG3792 Cooler Box 20L 20L 保温箱



盛夏光年

Midsummer picnic

COMFORT





KT3098 CAMP KING family

## 盛夏光年

### MIDSUMMER PICNIC

在盛夏时节，我们开车来到山间野餐，拜托朋友帮我们全家拍了这张照片。看着它，就好像看一副画，刚刚好的风景，刚刚好的阳光，刚刚好的表情.....在飞逝的流年中，这是我们永不会忘的幸福时刻

We drove into the hilly countryside for a midsummer picnic. My friend took a photo of all my family. Look, it is like a picture with the right landscape, the right amount of sunshine and the right feelings. We will never forget the feeling we had that day.



## 相关推荐

Related recommendation

### 露营 Camping

- KT3098 CAMP KING family
- KS3139 AIEBED SLEEPIN BAG 250D 双人气床睡袋
- KS3129 COMFORT 280D 双人舒适棉睡袋
- KS3127 COMFORT 280S 儿童棉睡袋
- KM3590 AIRBED DOUBLE 双人气床
- KM3589 内置气泵双人气床
- KA4921A 可拆分营地灯

### 野餐 Picnic

- KC3926 椭圆竹面桌
- KC3808 DeluxArmsChair 豪华扶手椅
- KC3904 竹面快速打开烧烤桌
- KG3793 保温箱
- KG2762 陶瓷卡式炉
- KP3903 CAMPER 4 露营 6 件套锅
- KA2741 VACUUM POT 1500ML 带拎手保温壶 1500ML
- KA2752 双盖保温杯



如此近的天空

The sky is so close

FAMILY





## 如此近的天空

### THE SKY IS SO CLOSE

周末去露营，撑起自驾露营全套装备，如同撑起一片静谧纯净的天空。女儿说，天变得好近，一伸手就能碰到。感谢这次露营，让我的小女儿说出这么诗意的话，让她做一个美梦。

We went camping at the weekend. We set up our auto-camping set. It looked like we had set up a clear blue sky. My daughter said "I feel the sky has become closer as if I can touch it with my out-stretched hand". I am thankful for this camping experience that it gave my daughter a beautiful and poetic dream.

KT3083 MEILFI



## 相关推荐

Related recommendation

### 露营 Camping

KT3083 MEILFI 梅尔菲  
 KS8015 OASIS 250+  
 KS3194 JUNIOR BOY 儿童睡袋  
 KM3560 BASECAMP COMFORT 可拼接舒适自充垫  
 KA1306 4 IN 1 RECHARGEABLE SPOTLIGHT CA  
 四合一手摇充电手电

### 野餐 Picnic

KC3956 6-SIDE FOLDING BAMBOO TABLE M 中号竹面六边桌  
 KC3818 ArmsChairinSteel 铁管扶手椅  
 KC3904 竹面快速打开烧烤桌  
 KG3793 保温箱 30L  
 KG2763 BASIC GAS STOVE 经典卡式炉  
 KP3903 CAMPER 4 露营 6 件套锅  
 KA2741 VACUUM POT 1500ML 带拎手保温壶 1500ML  
 KA2752 双盖保温杯

## 户外的理想国

### THE OUTDOORS: MY DREAM COUNTRY

离开过度喧嚣商业化的都市开车到户外，  
撑起帐篷搭起凉篷摆好桌椅，从蓝色的保温箱中拿出水果饮料，  
与你在清新的阳光中畅谈一番，这是与我的理想最接近的事。  
户外，就是我的理想国。

We drive away leaving the big bustle of the city behind.  
We set up the tents and the sunshade and take the food  
and drinks out of the blue cooler box. Spending a day  
in the sunshine with you is the closest to my dream day.  
The outdoors is my dream country.



KT3086 COMPASS



### 相关推荐

*Related recommendation*

#### 露营 Camping

- KT3086 COMPASS 多用途汽车篷
- KC3922 多功能装备车
- KC3802 铝管中号连体椅
- KG3793 保温箱 30L



KT3034 DOME JUNIOR

## 一种温暖在我的心里越来越满 A WARM IN MY HEART MORE FULL

一轮明月挂在夜空，篝火旁我教女儿认天上的星星。  
“爸爸，我困了，明天再看吧。”  
“好的，宝贝，回帐篷睡觉吧，爸爸还想再坐一会。”  
不一会女儿又回来了，小手中拿着一件冲锋衣，  
“爸爸，外面风大，小心着凉。”  
山风把我的头发吹得越发凌乱，一种温暖却在我的心里越来越满，这孩子开始懂事了。

The moon hanging in the sky,campfire I teach daughter recognize the stars in the sky.  
"Dad,I'm sleepy.tomorrow to see."  
"Ok,honey,back to the tents to sleep,dad would still like to sit down for a while."  
Different meeting daughter came back again,small hand one charge clothes,  
"dad,it's windy outside,be careful to catch a cold."  
Mountain wind blowing up my hair more messy,a warm,  
but in my heart more full,this child start sensibly.



### 相关推荐

Related recommendation

### 露营 Camping

KT3034 DOME JUNIOR 儿童帐篷  
KS3130 JUNIOR 200 儿童睡袋  
KC3897 青蛙儿童椅



## FLORENCE FANTASY

### KT7001

**产品信息:**

搭建/包装尺寸: 210X185X115cm/74X19X13cm

外帐: 190T涤纶, PU涂层, 防水1500mm

内帐: 185T透气涤纶

地席: 150D牛津布, PU涂层, 防水3000mm

支架: 铝合金速开支架

地钉: 8根铝合金地钉

拉绳: 4根防风拉绳

外袋: 150D牛津布拼190T涤纶防水拉链提袋

**产品特点:**

铝合金弹簧顶速开支架系统, 使用便捷安全;

防雨顶盖布设计, 外帐两侧篷布到底, 全方位提升防雨性能;

一帐两用, 外帐可单独作遮阳棚使用;

对开外纱帘D形门, 方便进出, 循环透气, 便于调节。

**Technical Specification:**

Set/Packaged Size: 210X185X115cm/74X19X13cm

Flysheet: 190T polyester, PU waterproof rated: 1500mm

Inner: 185T breathable polyester

Floor: 150D oxford PU waterproof rated: 3000mm

Pole: Aluminum quick-up Poles

Carrying bag: 150D oxford spliced 190T polyester waterproof zipper handbag

**Feature:**

Pre-assembled aluminum quick-up poles for fast and easy setup in about three minute. Two D-style door for easy entry with no-see-um mesh window, and closeable mesh windows for great cross ventilation.



单位:cm

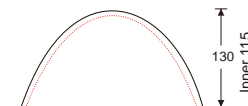
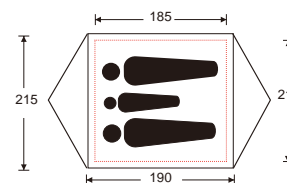

## CLASSIC FANTASY

### KM7002

产品信息：

上部面料：150D牛津布贴合PVC

底部面料：150D牛津布贴合PVC

气嘴：铜气嘴加工程塑料保护帽

外袋：150D牛津布

特点：

两侧子母扣设计，可无限自由拼接；

波浪形表面海绵，透气排汗；

铜气嘴设计，坚固耐用，快速充气放气。

Technical Specification:

TOP Fabric: 100%Polyester 150D PVC coating

Bottom Fabric:100%Polyester 150D PVC coating

Filling:Polyurethane Foam

Valve:brass with plastic cap

Carry bag: Oxford stuff sack

Feature: Attaches and Detaches Securely

Snap button and Very easy to add more pads to

extend the width freely. Jet Stream Wave Open

Cell Foam for faster inflating and deflating,

and add comfort. Free-flowing, non-corrosive

two brass valve make inflation and deflation

of the camping pad quick and easy.



(背面)

(正面)



## OASIS FANTASY

### KS7003

产品信息：

面料：100%聚酯纤维，防水、压光处理

里料：100%棉 法兰绒

填充：100%聚酯纤维250g/m<sup>2</sup> Comfort Loft

外袋：100%聚酯纤维 牛津布压缩提袋

产品特点：

内外双向双向拉链设计，左右款可拼接，

底部可单独拉开，保持脚部干爽；

可调节松紧半圆头帽结构，提升保暖性和舒适性。

Technical Specification:

Outer Fabric: 100% Polyester 190T w/p cire

Lining: 100% Cotton Flannel

Filling: 100% Polyester 250g/m<sup>2</sup> Comfort Loft

Carry bag: 210D Oxford compression bag

Features:

Adjustable drawstring half-circle mummy

hood keeps heads or pillows off the ground and

helps lock in heat. Unzip the bottom for

extra ventilation on warmer nights.

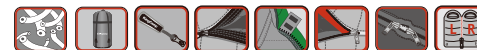
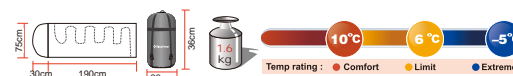





## MISSISSIPI FANTASY

### KT7004

产品信息：

搭建/包装尺寸: 240X140X130cm/81X14X14cm  
 外帐: 100%聚酯纤维, 190T涤纶, PU涂层, UPF 50+  
 地席: 100%聚酯纤维, 150D牛津布, PU涂层, 防水3000mm  
 支架: 抽绳滑轮式速开玻璃纤维支架  
 地钉: 6根铁地钉  
 提袋: 150D牛津布拼接190T涤纶拉链提袋  
 产品特点: 速开支架系统, 方便快速搭建;  
 一门三纱窗结构, 通风性强, 更好的夏日凉爽体验;  
 抗紫外线面料, 遮挡阳光, 更好保护身体。

Technical Specification:

Set/packed size: 240X140X130cm/81X14X14cm  
 Flysheet: 190T polyester, PU waterproof rated: 1200mm, UPF 50+  
 Floor: 150D oxford, PU waterproof rated: 3000mm  
 Pole: fiberglass quick-up poles  
 Features:  
 Specially designed quick-up frame System for fastest and easiest set up. UPF 50+ and PU coating waterproof fabric provide protection from the sun, rain and wind.

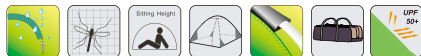

单位: cm

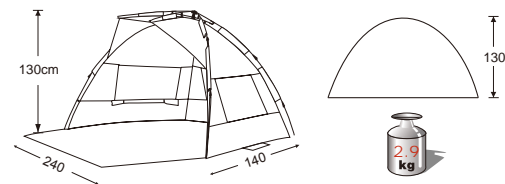

## PICNIC COOLER BASKET 野餐篮

### KG7005

产品信息：

尺寸: 44x25x25cm  
 材料: 100%聚酯纤维高强度耐磨牛津布;  
 铝箔保温内里  
 颜色: 青色+ Fantasy印花  
 配件: 野餐篮1个; 保温内胆1个  
 特点:  
 颜色时尚美观, 使用安全,  
 保温内胆可拆卸, 适合购物,  
 野餐保鲜, 折叠后体积小方便  
 携带, 易存放

Technical Specification:

Size: 44x25x25cm  
 Materials:  
 Shell fabric: 600x300D oxford with PVC coating  
 Inner fabric: 210D polyester and aluminum film  
 Color: cyan  
 Features:  
 Fashionable color, Safe for using  
 For shopping and camping  
 Easy carrying, Easy cleaning and storage  
 fabric provide protection from the sun,  
 rain and wind.



## PICNIC BLANKET 摇粒绒印花野餐垫

### KG7006

产品信息：

尺寸：200x150cm

材质：摇粒绒、海绵、PEVA

颜色：棕色/红色/绿色

特点：

手提包样式设计，方便携带，上盖有拉链口的储物袋。

摇粒绒表面柔软舒适，不掉毛，

对皮肤无害，使用安全健康。

PEVA底层，防水防潮。

适用于野餐休息。

Technical Specification:

Size: 200x150cm

Materials: Polar fleece

Color: cyan

Features:

Handbag style design;

Storage bag with zipper;

Polar fleece is soft and comfortable, safe to skin;

Bottom layer PEVA, damp proof.



## SUN SHADE UMBRELLA 遮阳伞

### KC7010

产品信息：

尺寸：伞面直径180cm

高度：120/180cm

伞面：100%聚酯纤维，PU涂层，防水1200mm,反面涂银，UPF50+

伞柄：22/25mm喷塑铁管

伞骨：玻璃纤维实心杆

颜色：青色

三角地插：镀锌铁

产品特点：

伞面印花设计独特时尚，伞的角度可以调节，

伞杆高度可以调节，地插设计更加牢固，

可以与桌子搭配使用，超轻量化，使用方便，便于携带。

Technical Specification:

Size: φ180x120/180cm

Material: 100% Polyester with PU waterproof rated 1200mm

Frame: Steel/Glass fiber

Color: Cyan

Features:

Special color design, Adjustable height

Safe for use in all activities, light weight

Carry bag for transportation and storage.



## COMPACT ALU ARM CHAIR 印花便携扶手椅

### KC7008

产品信息：  
 尺寸：83x54x43/78cm  
 面料：100%聚酯纤维加密高强度耐磨牛津布  
 支架：高强度铝合金支架  
 颜色：青色+Fantasy印花  
 特点：使用方便，舒适耐用，轻便，易携带。

Technical Specification:  
 Technical Specification:  
 Size: 83x54x43/78cm  
 Fabric: Extra strength 600D oxford cloth  
 Frame: Aluminum  
 Color: cyan  
 Features:  
 Open and fold in seconds; Safe for using;  
 Comfortable; Light Weight;  
 Carry bag for ease of transportation and storage



## BEACH CHAIR 木扶手沙滩椅

### KC7009

产品信息：  
 尺寸：54X55X60.5cm  
 面料：100%聚酯纤维加密高强度耐磨牛津布  
 支架：高强度铝合金支架  
 颜色：青色+Fantasy印花  
 特点：  
 全铝支架，木质扶手，金属连接件，  
 靠背弯管增加泡棉保护，  
 舒适耐用，轻便，易携带。

Technical Specification:  
 Size: 54X55X60.5cm  
 Fabric: 600X300D oxford  
 Frame: Aluminum  
 Features:  
 Lightweight; Stable;  
 Comfortable wood arms;  
 Carry bag for easy carrying.  
 Comfortable; Light Weight;  
 Carry bag for ease of transportation and storage.





## BURANO 布拉诺

### KT9005

产品信息：

搭建/包装尺寸：210x210x140cm/90x19x19cm

外帐：190T涤纶，PU涂层，防水1500mm

内帐：180T透气涤纶+B3纱网

地席：150D牛津布，PU涂层，防水3000mm

支架：玻璃纤维速开支架+铁门杆

地钉：16根铁地钉

拉绳：6根拉绳

外袋：150D牛津布拼190T涤纶拉链提袋

产品特点：

玻纤速开支架，快速搭建收纳；前出结构，加大遮阳面积；

内帐纱网结构，循环透气系；方顶结构提供宽大空间；

全包外帐结构，提升防雨性能。

Technical Specification:

Set/ Packaged Size:210x210x140cm/90x19x19cm

Flysheet: 190T Polyester, PU Waterproof: 1500 mm

Inner: 180T Polyester

Floor: 150D Oxford, PU waterproof rated: 3000 mm

Pole: fiberglass QUICK-UP poles

Carry Bag: 150D Oxford spliced 190T polyester zipper handbag

Features:

Quick-up system help you save much time.

Door awning can protect all from rain and sun.

Two mesh doors and two mesh windows can make the tent full ventilation,

keep you dry and comfortable.



NEW



单位:cm

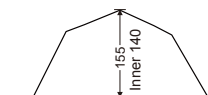
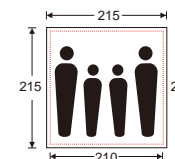
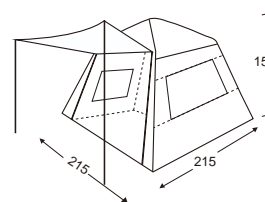



## CLASSIC RAINBOW KM9008

产品信息：  
 上部面料：100%聚酯纤维 150D牛津布贴合PVC  
 底部面料：100%聚酯纤维 150D牛津布贴合PVC  
 气嘴：铜气嘴加工程塑料保护帽  
 外袋：100%聚酯纤维 牛津布收口袋  
 产品特点：  
 波浪表面处理开孔海绵，快速充气放气，保持舒适；  
 铜气嘴设计，使用方便，寿命更长；  
 附赠收纳外袋、弹力捆扎织带以及修补包。

Technical Specification:  
 TOP Fabric:100%Polyester 150D Oxford PVC coating  
 Bottom Fabric:100%Polyester 150D Oxford PVC coating  
 Valve: Brass with ABS map  
 Carry bag: 150D Oxford stuff sack  
 Features: Jet Stream Wave Open Cell Foam;  
 Free-fl owing, non-corrosive brass valve;  
 included an oversized carrying bag ,  
 compression straps and Repair Kit.



(背面)

(正面)

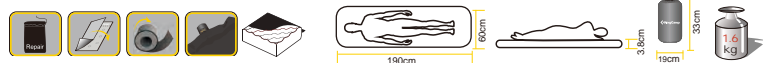

## RAINBOW 250 KS9009

产品信息：  
 面料：100%聚酯纤维，75D春亚纺,防水压光处理  
 里料：100%聚酯纤维  
 填充：100%聚酯纤维，250g/m<sup>2</sup> Comfort Loft  
 提袋：210D牛津布压缩提袋  
 产品特点：  
 牛津布压缩提袋，方便压缩携带；  
 抽绳帽檐以及拉链挡风条结构提升保暖性；  
 防夹拉链条设计方便顺滑使用；  
 外翻脖颈结构，提供舒适触感；  
 可拼接设计，两条单人款可拼接成双人款。

Technical Specification:  
 Outer Fabric: 100% Polyester 75D w/P  
 Lining: 100% Polyester 75D  
 Filling: 100% Polyester Comfort Loft 250g/m<sup>2</sup>  
 Carry bag:100% Polyester 210D Oxford Compression bag  
 Features:  
 Easy to compress and keep warm well.  
 Adjustable drawstring half-circle hood to  
 keep your head warm.  
 A left and a right sleeping bag can  
 be zipped together to make a double.  
 The zipper baffle will let the zipper goes well.  
 Carry bag for ease of transportation and storage.





## GARDA 加尔达

### KT9007

产品信息:  
 搭建尺寸: 400x380x230cm/65x12x12cm  
 外帐: 150D牛津布,PU涂层, 防水1500mm  
 支架: 2根铁管支架  
 地钉: 8根三角镀锌铁地钉  
 拉绳: 8根拉绳  
 外袋: 150D牛津布拉链双提手袋  
 产品特点:  
 多种用途, 可搭配帐篷、桌椅、野餐垫使用;  
 细节考究, 抗风性能优越, 经久耐用。

Technical Specification:  
 Set/Packaged Size:400x380x230cm/65x12x12cm  
 Flysheet: 150D Oxford, PU Waterproof:1500mm  
 Pole: steel poles  
 Carry Bag: 150D Oxford zipper handbag  
 Features:  
 Great for boating,camping,backpacking,  
 sporting events,and festivals;  
 Taped seams prevent water breach.

NEW

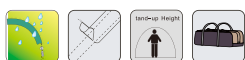

单位:cm

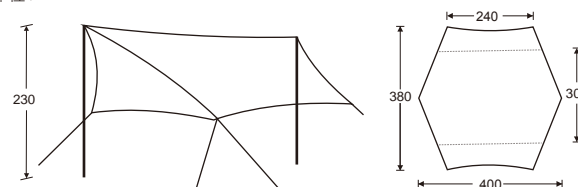



# POSITANO 波西塔诺

## KT3099

产品信息：  
 搭建/包装尺寸：210x210x135cm/82x18x18cm  
 外帐：190T涤纶，PU涂层，防水1500mm，UPF 50+  
 地席：150D牛津布，PU涂层，防水2000mm  
 支架：玻璃纤维速开支架  
 外袋：150D牛津布拼190T涤纶拉链提袋  
 产品特点：  
 速开支架，搭建方便，收纳快捷；  
 两门两窗结构，通风透气；  
 大前出设计，遮阳防雨；  
 方顶结构，户外自在舒适空间。

Technical Specification:  
 Set /Packaged Size:210x210x135cm/82x18x18cm  
 Flysheet:190T polyester,PU waterproof rated: 1500mm,UPF 50+  
 Floor:150D Oxford,PU waterproof rated:2000mm  
 Pole:fiberglass quick-up poles  
 Carry bag:150D Oxford spliced 190T polyester zipper handbag  
 Features:  
 Quick-up system help you save much time.  
 Extra large door awning can protect all from rain and sun.  
 Two mesh doors and two big mesh windows can  
 make the tent full ventilation, keep you dry and comfortable.

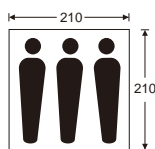
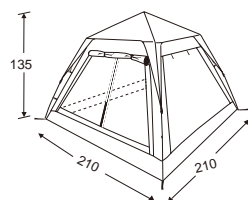

单位:cm

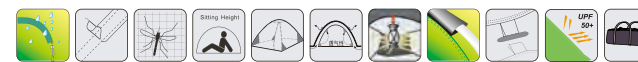



## SUPERIOR 苏必利尔 KT3084

### 产品信息：

搭建/包装尺寸: 360X360X210 cm /60XΦ20cm  
 外帐:100%聚酯纤维, KINGCAMP LEISURE防水处理, 防紫外线处理  
 支架: 3根直径11mm玻璃纤维支架  
 地钉: 10根铁地钉  
 拉绳: 6根防风拉绳  
 外袋: 100%聚酯纤维耐磨牛津布,防水处理  
**产品特点：**  
 搭建简便, 防撕裂格子面料结实耐用;  
 接缝处防雨贴条, 内壁涂防紫外线银涂层, 既遮阳又防雨;  
 顶部支架体弯曲处理, 给人更大使用空间;  
 帐内加内置口袋, 方便放置物品  
 用于露营和野餐时防雨, 遮阳使用。

### Technical Specification:

Set/packaged size:360X360X210 cm /60XΦ20cm  
 Flysheet:185T polyester, PU waterproof rated:  
 1500mm and silver coating UPF 50+  
 Pole:3 shock corded fiberglass poles  
 10 steel pegs, 6 windproof guy lines  
 Carry Bag:150D polyester PU waterproof compression bag  
**Features:**  
 Fashionable color;  
 Quilting the rain stickers,  
 wall coated UV silver coating, both sun and rain;  
 Extra durable Design for camping and picnics.

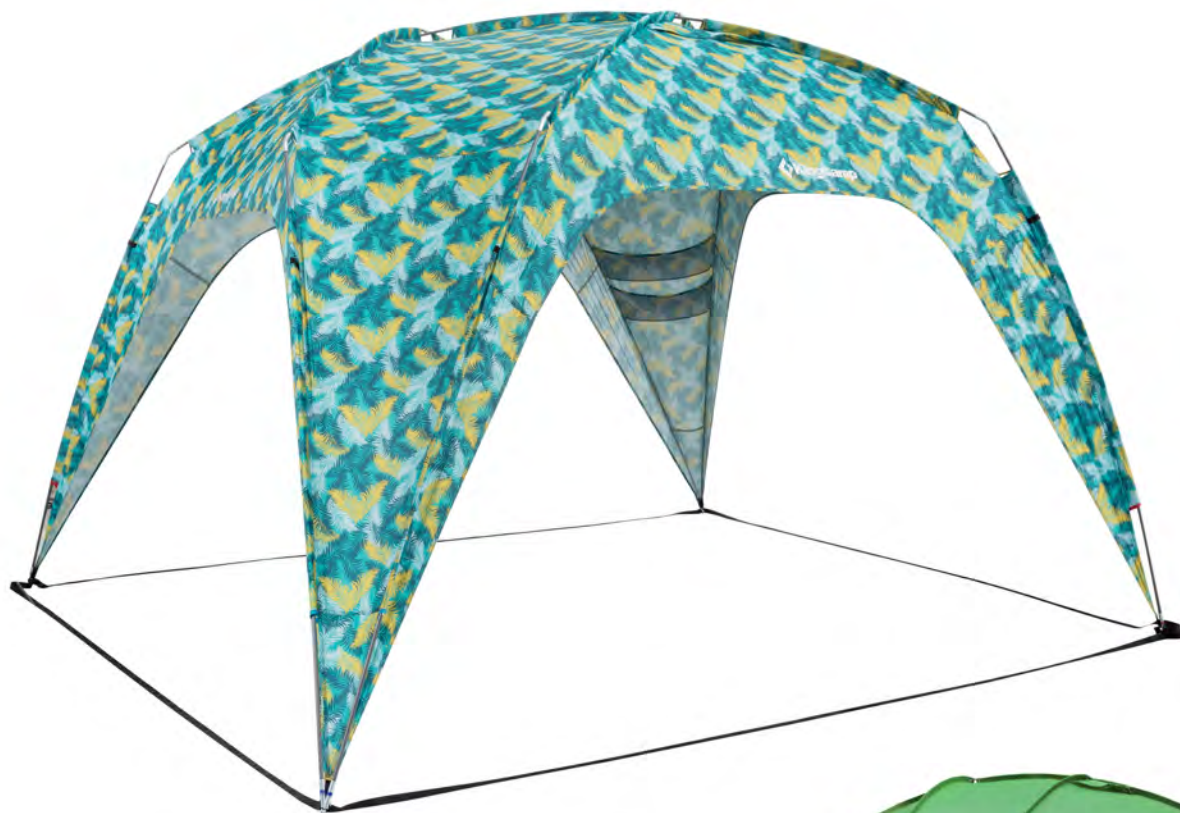

单位:cm

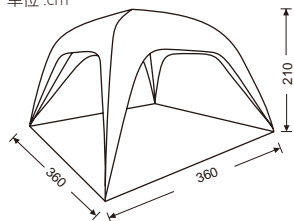

## ARM QUAD CHAIR 铁管扶手椅

**KC3818**

产品信息：  
尺寸：84x50x44/96cm  
面料：100%聚酯纤维高强度耐磨牛津布  
支架：铁管  
颜色：棕榈蓝，棕榈绿  
产品特点：  
美观时尚，舒适耐用，  
快速打开，使用方便，  
提袋设计，便于携带，  
户外家庭都能用。

Technical Specification:  
Size:84x50x44/96cm  
Fabric:600D Oxford  
Frame:Steel  
Color:Palm Blue,Palm Green  
Features:  
Fashionable color; Comfortable;  
Extra durable; Open and fold in seconds;  
Carry bag for transportation and storage.



NEW

## COMPACT CHAIR M 小号铁管连体椅

**KC3832**

产品信息：  
尺寸：42x42x66cm  
面料：100%聚酯纤维高强度耐磨牛津布  
支架：铁管  
颜色：棕榈绿  
产品特点：  
美观时尚，舒适透气，  
结实耐用，快速打开，  
使用方便，便于携带，  
户外家庭都能用。

Technical Specification:  
Size:42x42x66cm  
Fabric:600D Oxford  
Frame:Steel  
Color:Palm Green  
Features:  
Fashionable color;  
Breathable and comfortable;  
Extra durable; Open and fold in seconds;  
Carry bag for transportation and storage.



NEW



## COMFORT SOFA CHAIR M 中号舒适沙发椅

**KC3978**

产品信息：  
 尺寸：77x70x46/84cm  
 面料：100%聚酯纤维高强度耐磨牛津布  
 支架：铁管  
 颜色：棕榈绿  
 产品特点：  
 美观时尚，超级舒适，  
 快速打开，结实耐用，  
 使用方便，便于携带，  
 户外家庭都能用。

Technical Specification:  
 Size:77x70x46/84cm  
 Fabric:600D Oxford  
 Frame:Steel  
 Color:Palm Green  
 Features:  
 Fashionable color;  
 Extra comfortable;Extra durable;  
 Open and fold in seconds;  
 Carry bag for transportation and storage.



## COMFORT MOON CHAIR L 大号舒适QQ椅

**KC3816**

产品信息：  
 尺寸：84x70x40/80cm  
 面料：100%聚酯纤维高强度耐磨牛津布  
 支架：铁管  
 颜色：棕榈蓝，棕榈绿  
 产品特点：  
 美观时尚，舒适耐用，  
 快速打开，使用方便，  
 提袋设计，便于携带，  
 后背杂志袋，户外家庭都能用。

Technical Specification:  
 Size:84x70x40/80cm  
 Fabric:600D Oxford  
 Frame:Steel  
 Color:Palm Blue,Palm Green  
 Features:  
 Fashionable color;  
 Comfortable;Extra durable;  
 Open and fold in seconds;  
 Carry bag for transportation and storage.



## PICNIC BLANKET 沙滩垫/野餐垫

**KG4706**

产品信息：  
 尺寸：200x150cm  
 表层面料：190T涤塔夫印花布  
 填充：化纤棉  
 底部面料：600D牛津布  
 颜色：棕榈绿  
 产品特点：  
 提袋设计，便于携带，  
 鲜艳色彩，美观时尚，舒适耐用，  
 使用安全健康，适合沙滩、野餐、露营。

Technical Specification:  
 Size:200x150cm  
 Top Fabric:190T polyester taffeta printed cloth  
 Filling:100% Polyester  
 Bottom Fabric:600D Oxford  
 Color:Palm Green  
 Features:  
 Handbag style design for easy carrying;  
 Fashionable color; Durable and comfortable;  
 Safe for your skin; Suitable for picnic or camp.

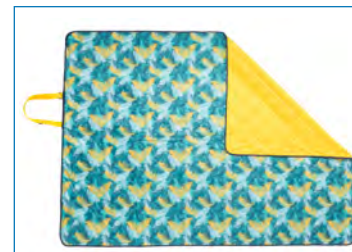

## KingCamp帐篷功能科技 KingCamp Tent Technical Information



外帐和地席防水功能  
Waterproof function for flysheet and floor



外帐和地席防水贴条  
Taped seam on flysheet and floor



高品质纱网  
High quality mosquito mesh to make sure bug free



适合高度 (坐着或站着)  
Height for sitting or standing



速搭支架系统  
QUICK UP SYSTEM



弹性自动支架系统  
POP UP SYSTEM



伸缩式速开支架系统  
Instant



内置口袋  
Inner pocket



支架袖结构  
pole sleeve construction



内帐顶部纱网吊兜方便放置日用品  
inner hanging mesh convenient for storing daily things



顶部吊环用于悬挂营地灯  
Ring for hanging the torch on the ceiling



电源接口  
Electrical cable access points



防紫外线保护  
UPF 50+



修补包  
repair knit



角部针环结构  
Pin and ring system in corner



角部气眼调节结构  
The pole can be fixed in different rings to adjust the tension of the tent in corner



角部气眼加梯扣调节结构  
The length of the guy loop can be adjusted in corner



角部针环加梯口调节结构  
Angle adjustable needle cycloadditions ladder mouth



挂钩结构  
Clips for attaching the inner tent to the poles



别棍结构  
Fixing hooks for flysheet ends or attaching the inner tent to the flysheet



三角片为双层方便存放拉绳  
Two layer tri-angel panels to help store the guy lines



反光拉绳便于夜间识别  
bright guy lines for extra visibility



KINGCAMP专门针对露营系列新开发的透气系统  
King camp new developed air ventilation system for great ventilation for camping



支架两端与对应的支架袖有相应统一的颜色标识  
Color coded poles match the poles to the sleeve tab for easy pitching



支架头内部有螺纹扣牢, 防止支架头被拔出  
Support head has internal threads fastened preventing the support head being pulled out



压缩提袋  
Compression outer bag



扁圆提袋  
Oblate bag



加强型拉链式提袋  
Reinforced carry bag with zipper



彩盒包装  
Packed in color box



阻燃标示  
FIRE RESISTANT

KingCamp 倡导幸福的理念, 将亲情, 爱情和友情与大自然的美结合。让人真正享受到天人合一的快乐。大自然给我们无尽的美, 但同时也时不时给我们一些挑战, 怎样让我们的出行能不受困扰, 同时又尽享旅游的快乐呢? KINGCAMP 全套成系列的产品给我们“精选”了“别致”、“专业”的装备, 让您的出行做到“无忧”。

快乐出行的第一步也是关键的一步就是选择合适的帐篷。KINGCAMP 的帐篷涵盖了登山, 徒步, 露营和休闲等各种运动类型。针对徒步系列中的轻便款式, 在原有基础上做了细节上更加人性化的提升, 拉绳加反光效果; 增加电源接口; 拉绳与外帐连接的三角片上加开口, 用于放拉绳; 内帐顶加吊兜; 角部增加可调节功能; 外袋侧面增加织带拎手; 增加修补包, 使用更方便。

2011年KINGCAMP推出采用我司准专利技术A.V.S透气系统的露营新款式, 采用此项技术将大大增强帐篷的通透性, 精巧的设计同时也兼顾了其它功能, 让您的出行更舒适。另外, 为了满足人们对于更多休闲空间的需要, 我们专门开发了豪华型大帐篷。同时, 面对琳琅满目的商品, 为了节约您选购的时间, KINGCAMP 专门为您准备好了整套的出行装备, 让您享受一站式购物的便捷。

KINGCAMP已为您准备好全套装备, 让我们一起出去户外, 学会爱!

KingCamp is dedicated to providing excellent, professional outdoor equipment worldwide to help you enjoy the natural landscape in a trouble-free way.

To have an enjoyable camping experience, the most important factor is to select the appropriate tent. The KingCamp tent range includes tents for all occasions - mountain camping, hiking & trekking, and leisure camping. For our customer's convenience, we have made many improvements in our hiking and trekking range such as brightening our guy lines, adding electrical access points, repair kits, etc.

In our camping range, we have developed a professional Air Ventilation System which ensures excellent ventilation. In addition, we have also developed deluxe tents to give you more space for leisure and entertainment.

To save your time in selecting your equipment, we have developed the Family Tent Pack, which contains most of the camping equipment you will require.

KingCamp has prepared a whole series of equipment for you. Let's go camping outside. Learn to love the outdoors.

KingCamp Leisure防水处理: PU防水涂层1000mm

KingCamp Camping防水处理: PU防水涂层2000mm

KingCamp Hiking防水处理: PU防水涂层5000mm

KingCamp Mountaineering防水处理: PU防水涂层10000mm



## APOLLO LIGHT 阿波罗 KT3002

### 产品信息：

搭建/包装尺寸：65×225×160×105cm/48×Φ19cm

外帐：100%聚酯纤维防撕裂格子布，KINGCAMP HIKING防水处理

内帐：100%聚酯纤维防撕裂格子透气网

地席：100%聚酯纤维耐磨牛津布，KINGCAMP MOUNTAINEERING防水处理

支架：3根直径8.5mm铝合金支架

地钉：17根铝合金地钉

拉绳：5根防风拉绳

外袋：100%聚酯纤维防撕裂格子布，防水压缩提袋

### 产品特点：

- 双层设计，雪裙设计，提供卓越的防雨，防风保护性；
  - 三根铝合金支架设计，帐篷支架抽设计，使帐篷稳定而坚固；
  - 配有多根防风固定绳，地钉保护，确保了完美的抗风性；
  - 内帐入口“D”形门设计，进出帐篷更加方便；
  - 外帐门和内帐门之间设有宽敞门厅用于存放装备；
  - 内帐内置口袋及顶部的纱网吊兜可用于存放随身物品；
  - 帐篷设有纱网通风孔，确保了卓越的透气性，在寒冷气候下减少内帐结霜的情况发生；
- 此款帐篷专门为高山或者恶劣天气野营而设计。

### Technical Specification:

Set/Packaged Size: 65×225×160×105cm/48×Φ19cm

Flysheet: 210T polyester rip stop, PU waterproof rated: 5000mm.

All seams are seam sealed and taped on flysheet

### Tent construction:

Tent walls-double wall construction; All walls are seam sealed & taped.

Inner: 210T breathable polyester rip stop

Floor: 150D oxford, PU waterproof rated: 10000mm,

all seams are seam sealed and taped.

Pole: 3-shock corded "ultra-lite" and durable aluminum poles

Carry bag: 210T polyester rip stop, PU waterproof compression bag

### Features:

Fully-covered vestibule for gear storage,

dry entry and added wind protection near the door.

Wide mud flap reinforced by straps for highly wind resistant and inner warmth.

Free standing pole system of three cross aluminum poles design with

weatherproof shock cord.

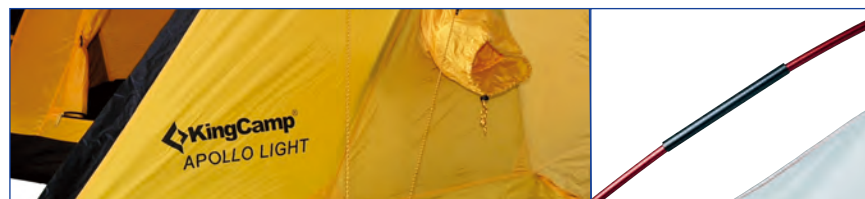

单位:cm

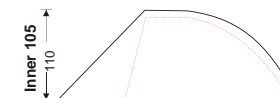
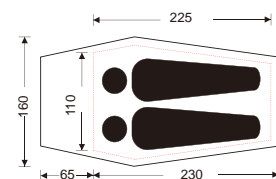
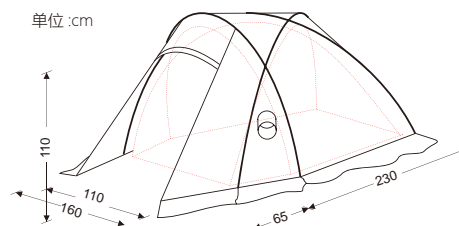

## SEINE 塞纳 KT3081

### 产品信息：

搭建/包装尺寸：60+145+60X210X110cm/50xΦ13cm

外帐：100%聚酯纤维防撕裂格子布，KINGCAMP HIKING防水处理

内帐：100%聚酯纤维透气网

地席：100%聚酯纤维耐磨牛津布，KINGCAMP MOUNTAINEERING防水处理

支架：2根直径为7.9mm铝合金支架

地钉：12根铝合金地钉

拉绳：4根防风拉绳

外袋：100%聚酯纤维耐磨牛津布，防水压缩提袋

### 产品特点：

双层设计，提供优越的防雨，防风保护性；

外帐采用防撕裂格子布，更高档结实耐用；

两根铝合金支架设计，内帐支架袖设计，使帐篷稳定而坚固。

内帐入口“O”形门设计，门一侧有三角形网袋便于门的收纳；

内帐大面积纱网，通透性极佳；黄色内帐，便于极度环境下求生时被人搜救；

外帐门和内帐门之间设有宽敞门厅用于存放装备

内帐内置口袋及顶部的纱网吊兜可用于存放随身物品

拉绳采用黄底黑点反光拉绳，既美观，又能起到防止夜行人被绊倒的效果；

此款帐篷专门徒步探险，露营，旅游，休闲设计

### Technical Specification:

Set/Packaged Size: 60+145+60X210X110cm/50xΦ13cm

Flysheet: 210T polyester rip stop, PU waterproof rated: 5000mm

All seams taped on fly-sheet

Inner: 180T breathable polyester

Floor: 150D oxford, PU waterproof rated: 10000mm, all seams taped on floor

Pole: 2 shock corded durable aluminum poles

Carry bag: 210T polyester PU waterproof compression bag

### Features:

"O"-style door with no-see-um mesh window,

and closeable mesh windows for great cross ventilation.

Reverse angle windows and door design with series of interworking

features guaranteed to keep you dry and comfortable.

Two fully-covered vestibule for gear storage,

dry entry and added wind protection near the door.

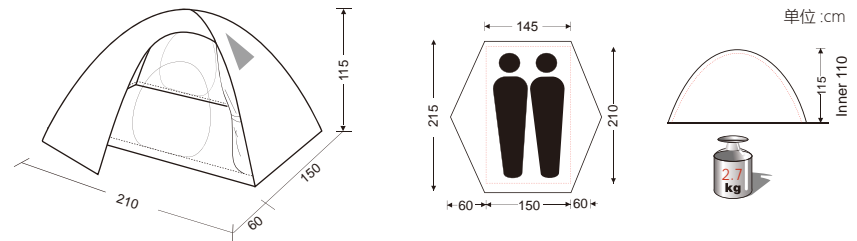



## HIKER 3 密苏里 3

### KT3021

产品信息：

搭建/包装尺寸：70+210×210×120cm/53xΦ15cm

外帐：100%聚酯纤维，KINGCAMP CAMPING防水阻燃处理

内帐：100%聚酯纤维透气网

地席：100%聚酯纤维耐磨牛津布，KINGCAMP HIKING防水处理

支架：2根直径8.5mm 玻璃纤维支架

地钉：15根铁地钉

拉绳：3根防风拉绳

外袋：100%聚酯纤维，牛津布拼涤纶拉链提袋

产品特点：

双层设计，提供优越的防雨，防风保护性

两根玻璃纤维支架设计，使帐篷稳定而坚固；

内帐挂钩设计，使内帐更独立使用；

内帐入口“U”形门设计，方便进入外帐门和内帐门之间

设有宽敞门厅用于存放装备

内帐内置口袋可用于存放随身物品

Technical Specification:

Set/Packaged Size: 70+210×210×120cm/53xΦ15cm

Flysheet: 185T polyester, PU waterproof rated: 3000mm.F/R

Inner: 180T breathable polyester

Floor: 150D oxford, PU waterproof rated: 5000mm

Pole: 2 shock corded fiberglass poles

Carry bag: 150D oxford PU waterproof compression bag

Features:

One fully-covered vestibule for gear storage, dry entry and added wind protection near the door.

Free standing, two pole design fiberglass poles for better windproof.

Mesh back roof vents increase ventilation and improve star gazing.



单位:cm

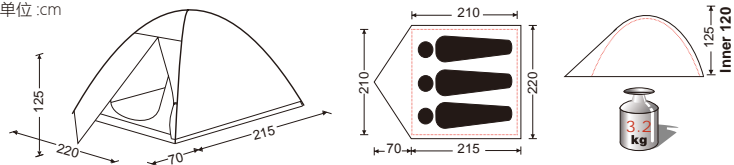

## BACKPACKER 布拉格 KT3019

**产品信息：**

搭建/包装尺寸：200X140X130cm/ 50X Φ15cm  
 外帐：100%聚酯纤维，KINGCAMP CAMPING防水处理  
 内帐：100%聚酯纤维透气网  
 地席：100%聚酯纤维耐磨牛津布，KINGCAMP HIKING防水处理  
 支架：2根直径为7.9mm玻璃纤维支架  
 地钉：12根铁地钉  
 拉绳：4根防风拉绳  
 外袋：100%聚酯纤维耐磨牛津布，防水压缩提袋

**产品特点：**

双层设计，提供优越的防雨，防风保护性  
 内挂式设计，外帐支架轴结构，可独立支撑，当作凉棚使用  
 两根玻璃纤维支架设计  
 倒“T”型双层门设计，方便进出，附有纱网，完美平衡透气性与保护性；  
 内帐内置口袋可用于存放随身物品  
 此款帐篷专门徒步探险，露营，旅游，休闲设计

**Technical Specification:**

Set/Packaged Size: 200X140X130cm/ 50X Φ15cm  
 Flysheet: 185T polyester, PU waterproof rated: 3000mm  
 Taped seams on fly-sheet  
 Inner: 180T breathable polyester  
 Floor: 150D oxford, PU waterproof rated: 5000mm, Taped seams on floor.  
 Pole: 2 shock corded fiberglass poles  
 Carry bag: 150D oxford, PU waterproof compression bag.  
**Features:**  
 Mesh roof vents increase ventilation and improve star gazing.  
 Free standing, two fiberglass poles design for better windproof.  
 Seams are Double-stitched, lap-felled to provide a shingle effect against water and all threads.



单位:cm

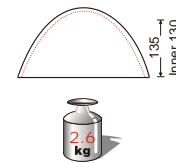
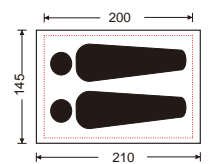



## MEILFI 梅尔菲 KT3083

**产品信息：**

搭建/包装尺寸:275X275X220cm/72xΦ26cm  
 外帐：190T涤纶,PU涂层,防水3000mm,阻燃  
 内帐：180T透气涤纶,B3纱网  
 地席：PE 130g/m<sup>2</sup>  
 支架：4根铁管侧边支架+4根玻纤顶部支架+2根铁管门杆  
 地钉：23根镀锌铁地钉  
 拉绳：8根拉绳  
 外袋：150D牛津布拉链双提手袋  
 产品特点：一顶帐篷多种用途：  
 内外帐结合作为露营帐篷使用；  
 外帐单独做凉篷使用；  
 创新性的无缝车体对接系统，无缝与车体连接，  
 变后备箱空间为帐篷储藏空间；  
 三门一窗结构，方便进出，循环透气，保持帐内凉爽。

**Technical Specification:**

Set/PackagedSize:275×275×220cm/ 72xΦ26cm  
 Flysheet: 190T polyester,  
 PU waterproof rated: 3000mm,F/R  
 Inner:180T breathable polyester  
 Floor:PE 130G/M<sup>2</sup>  
 Pole:Steel poles and fiberglass poles  
 Carry bag:150D oxford waterproof compression zipper handbag  
**Features:**  
 Universal adjustable vehicle sleeve fits all SUV's &  
 Minivans ,and convert cargo space into sleeping space.  
 Multi-Purpose:a vehicle tent ; a ground camping tent ;  
 a 9.5'x9.5'x7.5'canopy with 3 mesh door and 1 window.

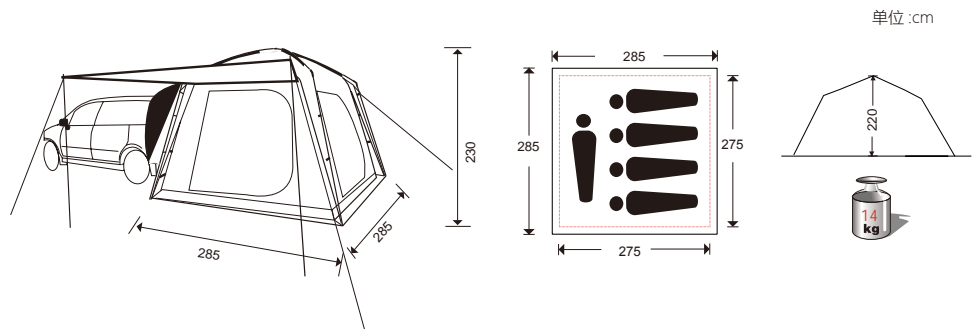

**HOLIDAY3 假日3 KT3018**

**HOLIDAY4 假日4 KT3022**

**HOLIDAY5 假日5 KT3028**

产品信息:

搭建/包装尺寸: 75+180×210×120cm / 50xΦ17cm (KT3018)  
 100+240×240×145cm / 55XΦ20cm (KT3022)  
 120+250×280×195cm / 60xΦ22cm (KT3028)

外帐: 100%聚酯纤维, KINGCAMP CAMPING防水阻燃处理  
 内帐: 100%聚酯纤维透气网  
 地席: 100%聚酯纤维耐磨牛津布, KINGCAMP HIKING防水处理  
 支架: 3根玻璃纤维支架  
 地钉: 25根铁地钉 (KT3018)  
 29根铁地钉 (KT3022 / KT3028)

拉绳: 8根防风拉绳  
 外袋: 100%聚酯纤维耐磨牛津布, 防水压缩提袋

产品特点:

此款帐篷分为三人帐KT3018, 四人帐KT3022和五人帐KT3028  
 双层设计, 提供卓越的防雨, 防风保护性;  
 三根玻璃纤维支架设计, 帐篷支架轴设计, 使帐篷稳定而坚固;  
 内帐挂钩设计, 方便快捷搭建, 内帐可独立支撑;  
 内帐入口“U”形门设计, 方便进入; 外帐顶部开纱窗, 增强透气性;  
 外帐门和内帐门之间设有宽敞门厅用于存放装备;  
 内帐内置口袋可用于存放随身物品。

Technical Specification:

This model has three sizes, KT3018 for 3 persons, KT3022 for 4 persons and KT3028 for 5 persons.

Set/Packaged Size:

75+180×210×120cm / 50xΦ17cm(KT3018)  
 100+240×240×145cm / 55XΦ20cm(KT3022)  
 120+250×280×195cm / 60xΦ22cm(KT3028)

Flysheet: 185T polyester, PU waterproof rated: 3000mm, F/R all taped seams on fly-sheet.

Inner: 180T breathable polyester

Floor: 150D oxford, PU waterproof rated: 5000mm

Pole: 3 shock corded fiberglass poles

Carry bag: 150D oxford, PU waterproof compression bag

Features:

Screened room with removable PE floor provides extra ventilation on warm days, great place for meals and gathering, rain or shine, and protected storage space. "U"-style door with no-see-um mesh window, and closeable mesh windows for great cross ventilation. Taped floor seams are Double-stitched, lap-felled to provide a shingle effect against water and all threads.



**KT3028 HOLIDAY5**

单位:cm

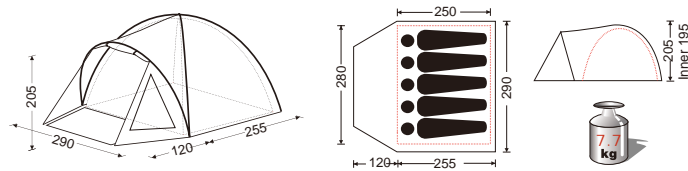

**KT3018 HOLIDAY3**

单位:cm

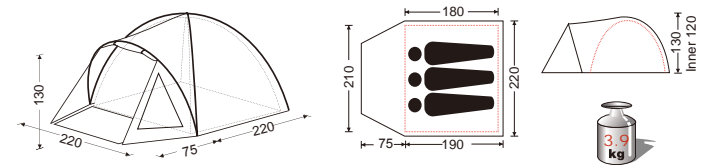

**KT3022 HOLIDAY4**

单位:cm

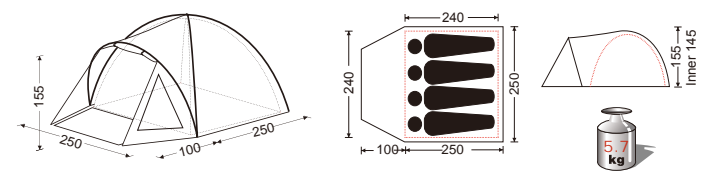



WEEKEND 3 周末3 KT3008

WEEKEND 5 周末5 KT3026

产品信息:

搭建/包装尺寸: 130+210x210x130cm/52xΦ18cm (KT3008)

175+275x275x180cm/60xΦ23cm (KT3026)

外帐: 100%聚酯纤维, KINGCAMP CAMPING防水阻燃处理

内帐: 100%聚酯纤维透气网

地席: 100%聚酯纤维耐磨牛津布, KINGCAMP HIKING防水处理

支架: 3根玻璃纤维支架

地钉: 30根铁地钉 (KT3008)

34根铁地钉 (KT3026)

拉绳: 8根防风拉绳

外袋: 100%聚酯纤维耐磨牛津布, 防水压缩提袋

产品特点:

双层设计, 提供优越的防雨, 防风保护性;

三根玻璃纤维支架设计, 使帐篷稳定而坚固;

内帐挂钩结构, 组装便捷, 可单独使用;

内帐入口倒“U”形门设计, 方便进入;

外帐门和内帐门之间设有宽敞门厅用于存放装备

内帐内置口袋可用于存放随身物品

Technical Specification:

Set/Packaged Size: 130+210x210x130cm/52xΦ18cm(KT3008)

175+275x275x180cm/60xΦ23cm(KT3026)

Flysheet: 185T polyester, PU waterproof rated: 3000mm, F/R

Inner: 180T breathable polyester

Floor: 150D oxford, PU waterproof rated: 5000mm

Pole: 3 shock corded fiberglass poles

Carry bag: 150D oxford, PU waterproof compression bag

Features:

Screened room with removable PE floor provides extra ventilation

on warm days, great place for meals and gathering, rain or shine,

and protected storage space."n"-style door with no-see-um mesh

window, and closeable mesh windows for great cross ventilation.

Taped floor seams are Double-stitched,

lap-felled to provide a shingle effect against water and all threads.



KT3008 WEEKEND 3

单位:cm

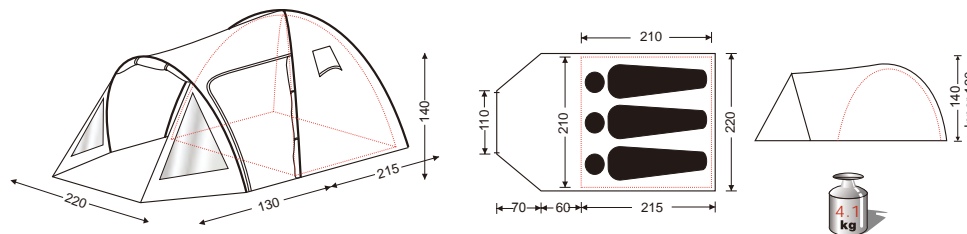

KT3026 WEEKEND 5

单位:cm

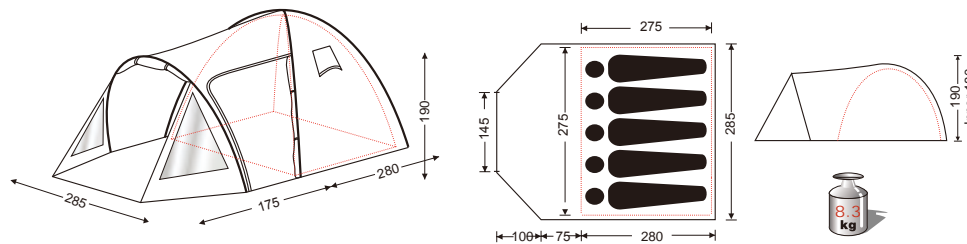

**BARI 4 巴里4 KT3030**

**BARI 6 巴里6 KT3031**

产品信息：  
 搭建/包装尺寸：  
 140+150+140x210x190cm/68xΦ23cm (KT3030)  
 180+140+180x210x200cm/70xΦ25cm (KT3031)  
 外帐：100%聚酯纤维，KINGCAMP CAMPING防水阻燃处理  
 内帐：100%聚酯纤维透气绸  
 地席：PE 135g/m2  
 支架：4根玻璃纤维支架+2根铁支架  
 地钉：46根铁地钉  
 防风拉绳：12根防风拉绳  
 外袋：100%聚酯纤维耐磨牛津布，防水压缩提袋  
 产品特点：  
 外帐支架轴结构，使帐篷稳定而坚固，且可单独使用；  
 宽敞客厅加前出，为户外生活提供自在舒适的空间；  
 外帐对开门结构，且门帘加上透明PVC，  
 既挡风又提升采光性和透气性；  
 两卧室一客厅，适合露营和自驾

Technical Specification:  
 This model has two sizes,  
 KT3030 for 4 persons, KT3031 for 6 persons.  
 Set/Packaged Size:  
 155+150+155x230x190cm/68xΦ23cm(KT3030)  
 180+140+180x230x200cm/70xΦ25cm(KT3031)  
 Flysheet: 185T polyester, PU waterproof rated: 3000mm,F/R  
 Inner: 180T breathable polyester  
 Floor: PE 135g/m2  
 Pole: 4 shock corded fiberglass poles & 2 steel poles  
 Carry bag: 150D oxford, PU waterproof compression bag.  
 Features:  
 2 Separated and Detachable rooms for 4&6 persons fully sealed and water proofed. Removable middle hall floor for cleaner interior space. Front and Back Doors for great cross ventilation and in or out convenience. Door Awning with 2 metal poles provide extra ventilation on warm days, great place for meals and gathering, rain or shine, and protected storage space.



**KT3030 BARI 4**

单位:cm

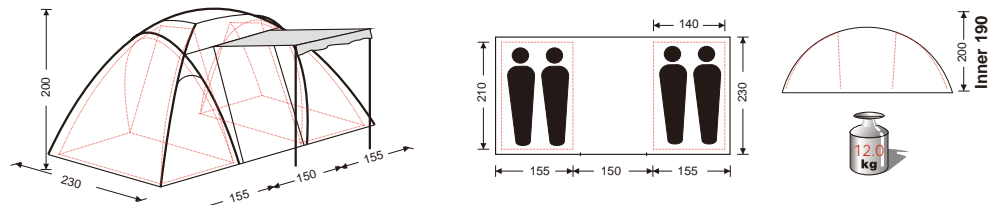

**KT3031 BARI 6**

单位:cm

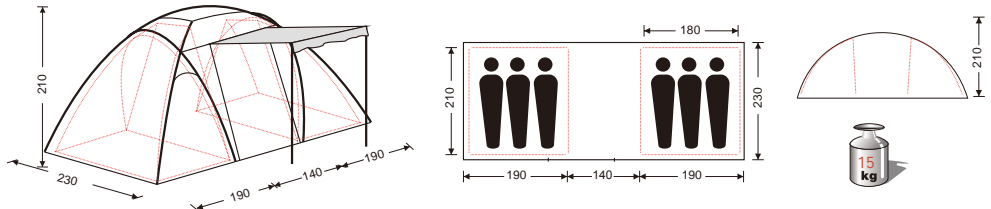





- MILAN 3 米兰3 KT3056
- MILAN 4 米兰4 KT3057
- MILAN 5 米兰5 KT3058
- MILAN 6 米兰6 KT3059

产品信息:

搭建/包装尺寸:

- 160+220X180X120cm/67x27x22cm (KT3056)
- 240+220X260X190cm /71x31x28cm (KT3057)
- 255+220X300X200cm /66x39x25cm (KT3058)
- 295+220X360X210cm/67x38x29cm (KT3059)

外帐: 100%聚酯纤维, KINGCAMP CAMPING防水处理

内帐: 100%聚酯纤维透气网

地席: PE 120G/M2

支架: 3根玻璃纤维支架+2根铁支架 (KT3056/KT3057/KT3058)

4根玻璃纤维支架+2根铁支架 (KT3059)

地钉: 22根铁地钉 (KT3056/KT3057/KT3058)

27根铁地钉 (KT3059)

拉绳: 12根防风拉绳 (KT3056/KT3057/KT3058)

14根防风拉绳 (KT3059)

外袋: 100%聚酯纤维耐磨牛津布, 防水压缩提袋

产品特点: 完全覆盖的隧道双层结构,

提供宽敞安全舒适的帐内休息和活动空间;

附加牛津布挡泥板的桶式地席结构, 有效提升防雨性能;

双门多窗设计, 有效提升帐内的空气循环流通度。

Technical Specification:

Set/Packaged Size: 160+220X180X120cm/67x27x22cm(KT3056)

240+220X260X190cm /71x31x28cm(KT3057)

255+220X300X200cm /66x39x25cm(KT3058)

295+220X360X210cm/67x38x29cm(KT3059)

Flysheet: 190T polyester, PU waterproof rated: 3000mm,F/R.

Inner: 190T breathable polyester

Floor: PE 120g/M2

Pole: fiberglass and steel poles

Carry bag: 210D oxford waterproof zipper handbag

Features:

Great fully-covered room provides great place for meals and gathering,

rain or shine, protected storage space,

dry entry and added wind protection near the door.

Polyester with a PU coating protects from top to bottom while the

PE tub-style floor with 210D Oxford mud flap combats water seepage.



KT3056 MILAN 3

单位:cm

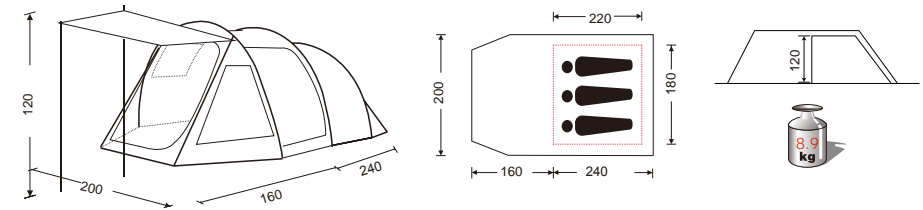

KT3057 MILAN 4

单位:cm

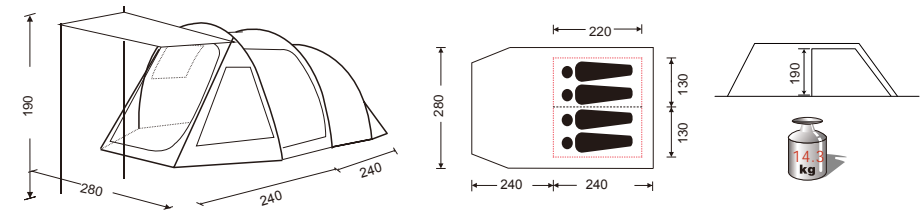

KT3058 MILAN 5

单位:cm

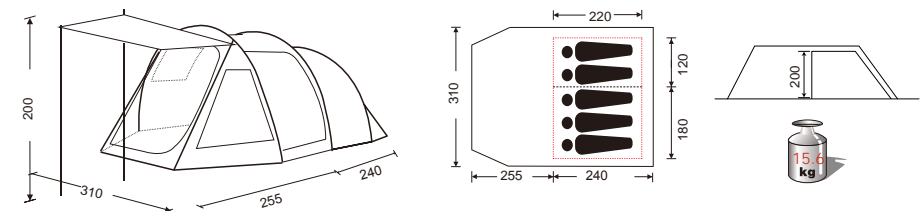

KT3059 MILAN 6

单位:cm

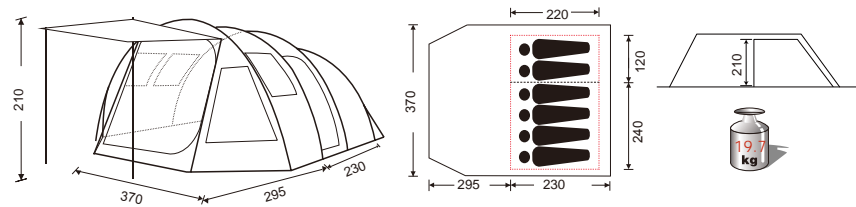

## ROMA 4 罗马4 KT3069

### 产品信息：

搭建/包装尺寸：520X240X195cm/74x22 x22cm  
 外帐：100%聚酯纤维，KINGCAMP CAMPING防水处理  
 内帐：100%聚酯纤维透气绸  
 地席：100%聚酯纤维耐磨牛津布，KINGCAMP HIKING防水处理  
 支架：3根直径11mm玻璃纤维支架+2根直径16mm的铁支架  
 地钉：33根铁地钉  
 拉绳：9根防风拉绳  
 外袋：100%聚酯纤维耐磨牛津布，防水压缩提袋

### 产品特点：

双层设计,提供优越的防雨,防风保护性;  
 前后门加侧门和侧窗设计, 通透性极佳;  
 支架与对应的支架袖上有鲜明的颜色标识,方便搭建时识别;  
 内帐入口“D”形门设计,方便进入;  
 外帐四周地裙设计,可很好的保持帐篷内温度,还能有效防止雨水泥沙溅入;  
 外帐门与内帐门之间设有高大宽敞的门厅,前门布帘可单独撑起,  
 给您提供充足的休闲空间.专为家庭露营休闲设计。

### Technical Specification:

Set/package size: 520X240X195cm/74x22 x22cm  
 Flysheet: 185T polyester, PU waterproof rated: 2000mm, all taped seams on flysheet.  
 Inner: 180T breathable polyester  
 Floor: 210D oxford, PU waterproof rated: 3000mm, all taped seams floor.  
 Pole: 3 shock corded fiberglass poles & 2 steel poles for entry canopy  
 Carry bag: 210D oxford, PU waterproof compression bag  
 Features:  
 Great fully-covered room with removable floor provides extra ventilation on warm days, great place for meals and gathering, rain or shine, protected storage space,dry entry and added wind protection near the door. Door rainfly convertible to an awning ,protection from rain and sun. Wide mud flap for water-resistance and inner warmth.

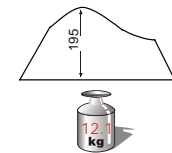
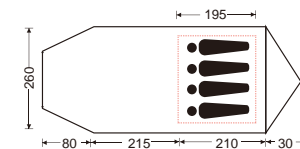
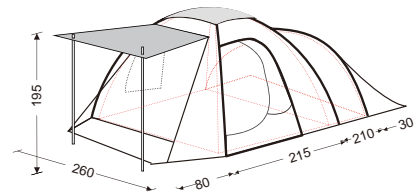



## WAKAYA 6 瓦卡亚6 KT3064

产品信息：

搭建尺寸：645X465X230/210/175cm

包装尺寸：100x60x35cm

外帐：100%聚酯纤维，KINGCAMP CAMPING防水处理

内帐：100%聚酯纤维透气网

地席：PE 140G/M2

支架：4根玻璃纤维支架+5根铁支架

地钉：81根铁地钉

拉绳：35根防风拉绳

外袋：100%聚酯纤维耐磨牛津布，防水压缩提袋

产品特点

双层设计,提供卓越的防雨,防风保护性

内帐入口为D形设计,方便进入.

外帐门与内帐门之间设有宽敞的门厅用于休闲或存放物品

内帐内置口袋方便存放物品.

专为家庭露营,休闲设计.

Technical Specification:

Set size: 645X465X230/210/175cm

Packaged size: 100x60x35cm

Flysheet: 185T polyester,

PU waterproof rated: 3000mm,

all taped seams on flysheet

Inner: 180T breathable polyester

Floor: PE 140G/M2 all taped seams on floor.

Pole: 4 shock corded fiberglass poles & 5 steel poles.

81 steel pegs, 35 guy lines.

Carry bag: 210D oxford PU waterproof compression bag

Features:

Adjustable tension straps & bright guy lines for

extra visibility Color coded poles match the poles to the

sleeve tab for easy set-up Fully sewn in groundsheet

creates a warm, bug free environment for living area.

Roomy vestibule, built-in storage pocket for better storage

Designed for family camping.



单位:cm

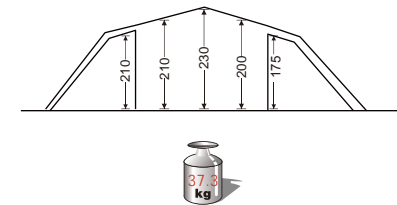
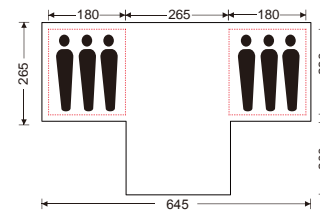
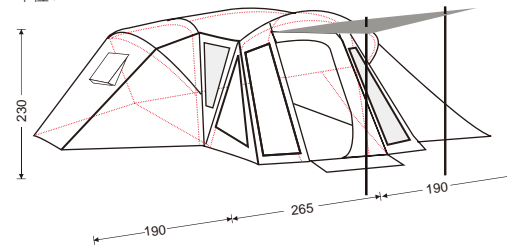

## CAMP KING KT3096

产品信息：

搭建/包装尺寸：240x210x157cm/97 x19 x19cm  
 外帐：100%聚酯纤维，KINGCAMP CAMPING防水处理  
 地席：PE 130g/M2  
 支架：伸缩式铁杆自动支架  
 铁地钉：10根铁地钉  
 拉绳：6根拉绳  
 外袋：100%聚酯纤维 耐磨牛津布拼涤纶拉链提袋

产品特点：

铁杆自动支架系统，收合方便，安全美观；  
 顶部以及四面大面积B3纱网设计，  
 既保证安全隐私又具有超佳透气性；

Technical Specification:

Set/Packaged Size: 240x210x157cm/97 x19 x19cm  
 Flysheet: 190T polyester, PU waterproof rated:1200mm  
 Floor: PE 130G/M2  
 Pole: Instant steel poles

Carrying bag: 150D oxford spliced 190T polyester zipper handbag

Features:

Pre-assembled steel poles for fast and easy set-up in about a minute.  
 Door rainfly convertible to an awning ,protection from rain and sun.  
 Large side and top windows for ventilation keep you dry and comfortable.



单位:cm

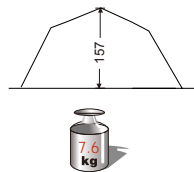
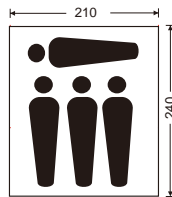
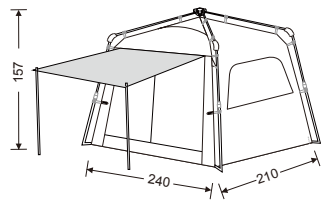



## CMAP KING PLUS KT3097

**产品信息：**

搭建尺寸：240x240x190cm/260x260x200cm  
 包装尺寸：120x19x19cm  
 外帐：150D牛津布，PU涂层，防水1500mm，UPF 50+  
 内帐：190T涤纶，PU涂层，防水2000mm  
 地席：150D牛津布，PU涂层，防水3000mm  
 支架：铁管速开支架  
 外袋：150D牛津布拉链提袋

**产品特点：**

伸缩式铁管速开支架，经久耐用，快速打开，方便收纳；  
 外帐面料防紫外线处理，可单独做遮阳篷使用；  
 一门三窗结构，通气透气性好；  
 方顶结构，户外享受大空间。

**Technical Specification:**

Set Size:240x240x190cm/260x260x200cm  
 Packaged Size:120x19x19cm  
 Flysheet:150D Oxford,PU waterproof rated:1500mm,UPF 50+  
 Inner:190T polyester,PU waterproof rated:2000mm  
 Floor:150D Oxford, PU waterproof rated:3000mm  
 Pole:Instant steel poles  
 Carry bag:150D oxford waterproof zipper handbag

**Features:**

With pre-assembled steel quick-up poles you can put up or pack up in seconds.  
 The removable inner that allows you use the flysheet alone as a canopy.  
 The front for easy entry and three windows makes sure the tent ventilated and cool.



单位:cm

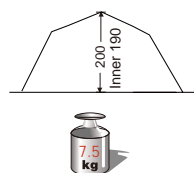
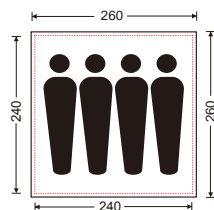
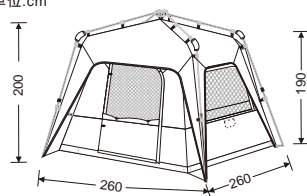



## CAMP KING family

### KT3098

产品信息：

搭建/包装尺寸：396x275x198cm/120x 25 x 25cm

外帐：100%聚酯纤维，KINGCAMP CAMPING防水阻燃处理

内帐：100%聚酯纤维，KINGCAMP LEISURE防水处理

地席：PE 130G/M2

支架：伸缩式铁杆自动支架

铁地钉：20根铁地钉

拉绳：8根拉绳

外袋：100%聚酯纤维 耐磨牛津布拉链提袋

产品特点：

预装第五代伸缩杆式铁管速开安全支架系统，快速便捷搭建收纳；

内置拉链屏风结构，分割内帐空间，有效提升内帐空间利用效率；

三门一窗结构，单独支撑全封闭B3网纱内帐，提升透气性能

Technical Specification:

Set/Packaged Size: 396x275x198cm/120x 25 x 25cm

Flysheet: 190T polyester, PU waterproof rated:3000mm,F/R

Inner:190T polyester, PU waterproof rated:600mm

Floor: PE 130G/M2

Pole: Instant steel poles

Carry bag: 500D oxford zipper handbag

Features:

Pre-assembled steel poles for fast and easy setup or taken

down in about 8 minute or less. 3 mesh inner doors ,

great back and top mesh windows for full ventilation keep

you dry and comfortable. Two Door rainfly convertible

to two awning ,protection from rain and sun.



单位:cm

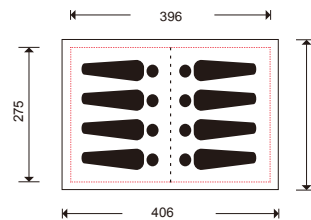
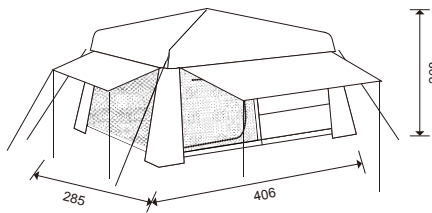

NEW

## MONZA BEACH KT3082

### 产品信息：

搭建/包装尺寸：210 × 210 × 130cm/74×14×14cm  
 外帐：100%聚酯纤维，KINGCAMP LEISURE防水处理  
 地席：100%聚酯纤维，KINGCAMP LEISURE防水处理  
 支架：玻璃纤维速开支架  
 铁地钉：8根铁地钉  
 拉绳：4根拉绳  
 外袋：150D牛津布拼接190T涤纶拉链提袋

### 产品特点：

玻璃纤维自动支架系统，快速收支，使用方便，结构稳定；  
 大空间，三门一窗，通风性能好，舒适度佳；  
 适用面广，适合公园休闲，自驾旅行等多种场合。

### Technical Specification:

Set/Packaged Size: 210x210x130cm/74x14x14cm  
 Flysheet: 190T polyester, PU waterproof rated: 450mm  
 Floor: 150D Oxford, PU waterproof rated: 3000mm  
 Pole: fiberglass quick up poles  
 Carry bag: 150D Oxford spliced 190T polyester zipper handbag  
 Features:  
 QUICK UP SYSTEM;  
 BREATHABLE;  
 STABLE-WIND PROOF;  
 EASY TO CARRY.

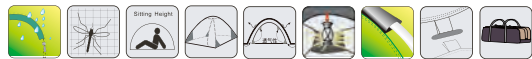
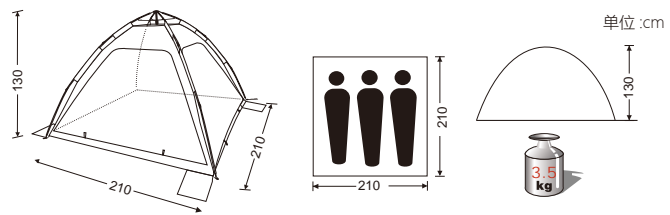

**MODENA 2 摩德纳 2 KT3036**

**MODENA 3 摩德纳 3 KT3037**

产品信息：  
 搭建/包装尺寸：205x150x105cm/Φ61X5cm (KT3036)  
 210x210x130cm/Φ70X5cm (KT3037)

外帐：100%聚酯纤维，KINGCAMP LEISURE防水处理

地席：100%聚酯纤维，KINGCAMP LEISURE防水处理

支架：弹性玻璃纤维自动支架

地钉：8根铁地钉

拉绳：4根防风拉绳

外袋：100%聚酯纤维，牛津布拼涤纶拉链提袋

产品特点：

全自动速开弹性支架系统，使用方便快捷；

顶部以及背部纱窗设计，循环透气，

保持帐内干燥舒适。

Technical Specification:

Set/packaged size:205x150x105cm/Φ61X5cm(KT3036)

210x210x130cm/Φ70X5cm(KT3037)

Flysheet:190T polyester,PA waterproof rated:300mm

Floor:150D oxford, PU waterproof: rated: 1000mm

Pole: fiberglass pop-up poles

Carry Bag:150D oxford spliced 190T polyester zipper oblate hand

Features:

Pre-assembled Pop-up fiberglass poles for easy 1-minuter set up or tear down.One semicircle front door for easy entry with no-see-um mesh window, and a closeable mesh back and a top windows for great cross ventilation.

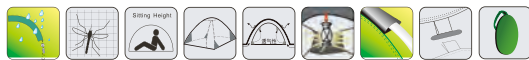

**KT3036 MODENA 2** 单位:cm

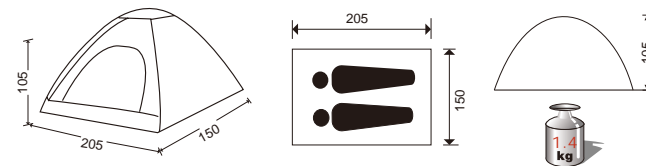

**KT3037 MODENA 3** 单位:cm

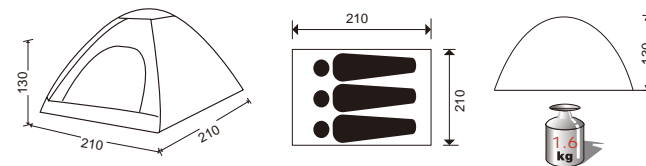



## ELBA 3 厄尔巴 3 KT3038

产品信息：

搭建/包装尺寸：80+180×210×120cm/Φ72X5cm

外帐：100%聚酯纤维，KINGCAMP CAMPING防水处理

内帐：100%聚酯纤维透气网

地席：100%聚酯纤维耐磨牛津布，KINGCAMP CAMPING防水处理

支架：弹性玻璃纤维自动支架

地钉：12根铁地钉

拉绳：4根防风拉绳

外袋：100%聚酯纤维，牛津布拼涤纶拉链提袋

产品特点：

全自动速开弹性支架系统，使用方便快捷，经久耐用；

宽敞封闭门厅空间，方便放置背包、鞋子等装备；

顶部纱网设计，提升透气性，保持帐内凉爽。

Technical Specification:

Set / Packaged Size: 80+180×210×120cm/Φ72X5cm

Flysheet:190T polyester, PU waterproof rated: 3000mm.

Inner:180T breathable polyester

Floor:150D oxford, PU waterproof rated:3000mm

Pole:fiberglass pop-up poles

Carry bag:150D oxford spliced 190T polyester zipper handbag

Features:

Pre-assembled Pop-up fiberglass poles for easy 1-minute set up or tear down.

Fully-covered vestibule for gear storage, dry entry and added wind protection near the door. Mesh roof vents and "D"-style door with outer mesh

increase ventilation and improve star gazing.



单位:cm

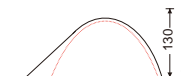
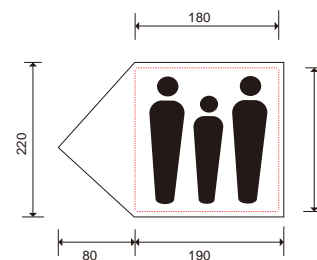

## TUSCANY 3 托斯卡纳 3 KT3039

**产品信息：**

搭建/包装尺寸：200×180×115cm/Φ72X8cm

外帐：100%聚酯纤维，KINGCAMP CAMPING防水处理

内帐：100%聚酯纤维透气网

地席：100%聚酯纤维耐磨牛津布，KINGCAMP CAMPING防水处理（内帐）

PE 120g/m<sup>2</sup>（外帐单用）

支架：弹性玻璃纤维自动支架（外帐）

2根玻璃纤维支架（内帐单用）

地钉：14根铁地钉

拉绳：4根防风拉绳

外袋：100%聚酯纤维，牛津布拼涤纶拉链提袋

**产品特点：**

全自动速开弹性支架系统，使用方便快捷，经久耐用；

一帐三用：内外帐组合使用；外帐单独使用；

内帐单独使用；半纱网内帐结构，对开门，通透性好，循环透气。

**Technical Specification:**

Set / Packaged Size: 200×180×115cm/Φ72X8cm

Flysheet: 190T polyester, PU waterproof rated: 3000mm.

Inner: 180T breathable polyester

Floor: 150D oxford, PU waterproof rated: 3000mm (Inner)

PE 120g/M2 (Flysheet)

Pole: fiberglass pop-up poles (Flysheet)

Fiberglass poles (Inner)

Carry bag: 150D oxford spliced 190T polyester zipper handbag

**Features:**

Pre-assembled Pop-up fiberglass poles for easy 1-minute set up or tear down.

Multi-Purpose: a camping tent; use inner only with 2 poles for Free standing;

use flysheet only with with removable PE floor for a awnings.

Mesh roof vents and 2 "D"-style door with outer mesh increase ventilation and improve star gazing.



单位:cm

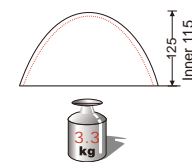
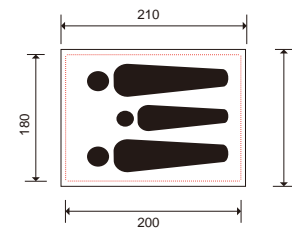
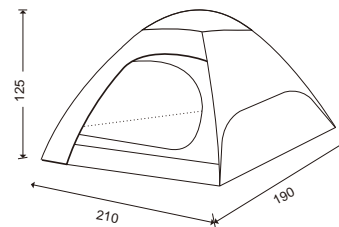

NEW

**MODENA MESH**  
**KT3032**

产品信息:  
 搭建/包装尺寸: 210x100x95cm /Φ56x4cm  
 外帐: 100%聚酯纤维,B3纱网  
 地席: 100%聚酯纤维, KINGCAMP LEISURE防水处理  
 支架: 弹性玻璃纤维支架  
 铁地钉: 8根铁地钉  
 拉绳: 4根拉绳  
 外袋: 150D牛津布拼接190T涤纶拉链提袋  
 产品特点:  
 弹性支架, 一抛即开, 方便使用;  
 透气, 防蚊虫, 多场合使用。

Technical Specification:  
 Set/ Packaged Size: 210x100x95cm /Φ56x4cm  
 Flysheet: 190T Polyester+B3 Mesh  
 Floor:150D Oxford, PU Waterproof Rated:1000mm  
 Pole: Pop-Up Fiberglass Poles  
 Carry Bag:150D Oxford Spliced 190T Polyester Waterproof Zipper Oblate Handbag  
 Features:  
 LIGHTWEIGHT AND PORTABLE; INSTANT;  
 BREATHABLE AND Anti-mosquito.

**POP UP SYSTEM**

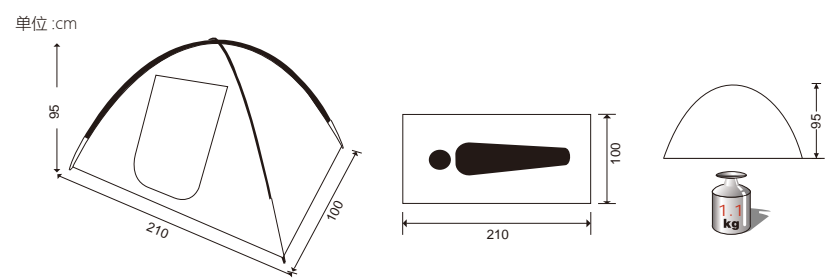
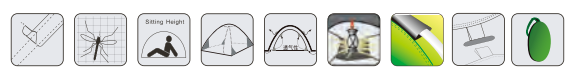



**FAMILY 2+1 幸福2+1 KT3012**  
**FAMILY 3 幸福3 KT3073**

产品信息:

搭建/包装尺寸: 205X180X120cm/56XΦ15cm (KT3012)  
 205X205X130cm/56XΦ15cm (KT3073)

外帐: 100%聚酯纤维, KINGCAMP LEISURE防水处理

内帐: 100%聚酯纤维透气网

地席: 100%聚酯纤维耐磨牛津布,

KINGCAMP CAMPING防水处理

支架: 3根直径8.5mm玻璃纤维支架

地钉: 8根铁地钉

拉绳: 4根防风拉绳

外袋: 100%聚酯纤维耐磨牛津布,防水压缩提袋,彩盒包装

产品特点:

双层设计

内帐挂钩结构,可单独支撑使用;

双挑檐结构,避风挡雨,可存储户外装备;

双开“n”型门,方便进出,提升透气性;

内帐内置口袋可用于存放随身物品

专为家庭露营,休闲旅游设计

Technical Specification:

Set/packaged size: 205X180X120cm/56XΦ15cm(KT3012)  
 205X205X130cm/56XΦ15cm(KT3073)

Flysheet: 185T polyester, PU waterproof rated: 1500mm,  
 all taped seams on flysheet.

Inner: 170T breathable polyester

Floor: 150D oxford, PU waterproof rated: 3000mm,  
 all taped seams on floor.

Pole: 3 shock corded fiberglass poles

8 steel pegs, 4 guy lines.

Carry Bag: compression bag, color box packing

Features:

It features a single room with the third pole creating a vestibule,  
 giving an area for storing gear and weather protection.

Two “n”-style door with no-see-um mesh window for easy entry,  
 and closeable mesh windows for great cross ventilation.



**KT3012 FAMILY2+1** 单位:cm

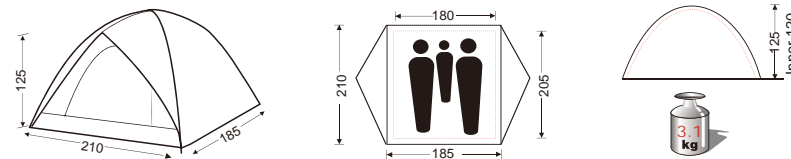

**KT3073 FAMILY3** 单位:cm

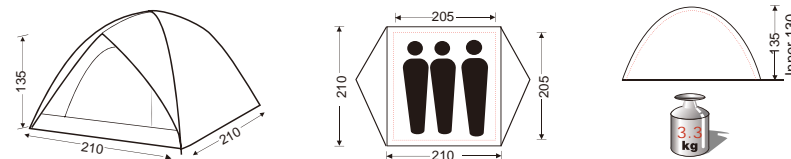

**MONODOME 2 好运2 KT3016**  
**MONODOME 3 好运3 KT3010**

产品信息:

搭建/包装尺寸: 205x150x105cm/51x11 x11cm (KT3016)  
 210x210x130cm/55x15 x15cm (KT3010)

外帐: 100%聚酯纤维, KINGCAMP LEISURE防水处理

地席: PE 10X10 120/M2

支架: 2根直径7.9mm玻璃纤维支架

地钉: 8根铁地钉

拉绳: 4根防风拉绳

外袋: 100%聚酯纤维, 涤纶拉链提袋

产品特点:

单层结构, 搭建便捷; 拉链外袋, 方便携带;

用于休闲旅游, 沙滩休息。

Technical Specification:

Set/packaged size:205x150x105cm/51x11 x11cm(KT3016)

210x210x130cm/55x15 x15cm(KT3010)

Flysheet:170T polyester, PA waterproof rated: 300mm

Floor:PE 10X10 120G/M2

Pole:2 shock corded fiberglass poles 8 steel pegs,4 guy lines.

Carry Bag:170T polyester zipper handbag

Feature:Single-layer ultra-light weight for easy carrying

Ideal for travel and beach shade.



**KT3016 MONODOME II** 单位:cm

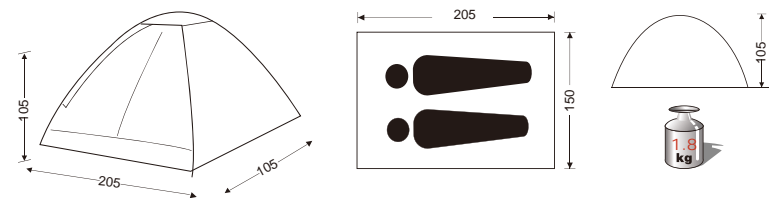

**KT3010 MONODOME III** 单位:cm

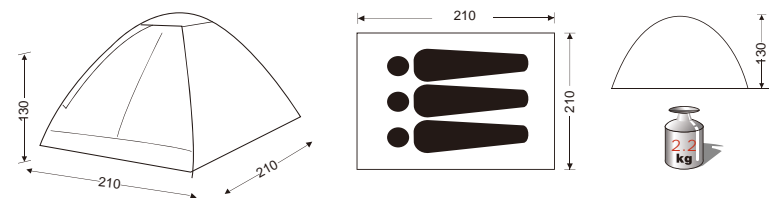

## VINCI 芬奇 KT3033

产品信息：  
 搭建/包装尺寸：190x120x95cm/54x14x14cm  
 外帐：T/C,180g/m<sup>2</sup>，PA涂层，防水3000mm  
 地席：150D牛津布，PU涂层，防水1000mm  
 支架：2根直径16mm铝合金支架  
 地钉：12根铝合金地钉  
 拉绳：8根拉绳  
 外袋：T/C布拼接牛津布拉链提袋

产品特点：  
 可手绘面料，给自己一顶独特的帐篷；  
 外帐防水T/C面料，提供帐内更凉爽环境同时可涂鸦；  
 双开门设计，两侧大纱网结构，循环透气；  
 两侧挑檐结构，更能遮阳防雨。

Technical Specification:  
 Set /Packaged Size: 190x120x95cm/54x14x14cm  
 Flysheet: T/C, PA Waterproof Rated:300mm  
 Floor:150D Oxford, PU Waterproof Rated:1000mm  
 Pole: Aluminum Poles  
 Carry Bag:150D Oxford Spliced T/C Waterproof Zipper Handbag  
 Features:  
 You can draw or graffiti on the unique t/c fabric;  
 waterproof and mold resistant;  
 breathable and durable;  
 Two door and four mesh vents help improve air flow and temperature management.



单位:cm

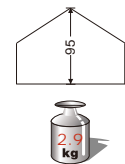
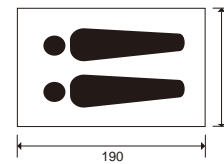
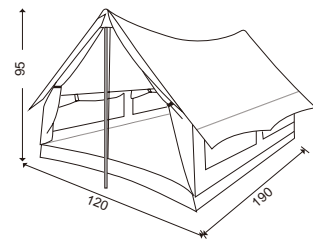



## DOME JUNIOR KT3034

产品信息：  
 搭建/包装尺寸：150×120×90cm/ 45X 10 X 10cm  
 外帐：100%聚酯纤维，KINGCAMP LEISURE防水处理  
 地席：100%聚酯纤维，KINGCAMP LEISURE防水处理  
 支架：2根玻璃纤维支架  
 地钉：8根铁地钉  
 拉绳：4根防风拉绳  
 外袋：100%聚酯纤维，牛津布拼涤纶拉链提袋  
 产品特点：  
 单层结构，搭建便捷；顶部纱网以及背部纱窗循环透气系统。

Technical Specification:  
 Set/package size:150×120×90cm/ 45X 10 X 10cm  
 Flysheet:190T polyester,PA waterproof rated: 300mm  
 Floor:150D oxford,PU waterproof:1000mm  
 Pole:fiberglass poles  
 Carry Bag:150D oxford spliced 190T polyester zipper oblate handbag  
 Features:  
 Portable Carrying bag with handles for easy transport and Packs up flat for easy storage.One semicircle front door for easy entry with no-see-um mesh window, and a closeable mesh back and a top windows for great cross ventilation.



单位 :cm

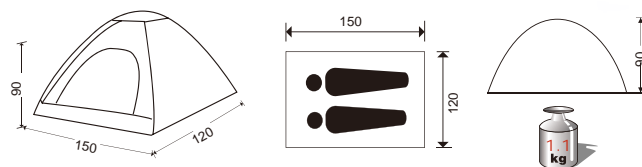

## VENICE 威尼斯 KT3071

产品信息：  
 搭建/包装尺寸：225X120X95cm/Φ72X4cm  
 外帐：100%聚酯纤维，KINGCAMP LEISURE防水处理  
 地席：100%聚酯纤维耐磨牛津布，KINGCAMP CAMPING防水处理  
 支架：弹性玻璃纤维自动支架  
 地钉：8根铁地钉  
 拉绳：4根防风拉绳  
 外袋：100%聚酯纤维，涤纶拉链外袋  
 产品特点：颜色时尚亮丽，双开门结构，透气性佳；  
 弹性支架系统，快速搭收使用方便，专为休闲旅游设计

Technical Specification:  
 Set/package size: 225X120X95cm/Φ72X4cm  
 Flysheet:190T polyester, PU waterproof rated:800mm  
 Floor:150D oxford, PU waterproof rated: 3000mm  
 Pole:fiberglass pop-up poles  
 8 steel pegs, 4 windproof guy lines  
 Carry bag:190T polyester oblate zipper handbag  
 Feature:  
 Easy to set up and fold up  
 Fashion color,Design for leisure



单位 :cm

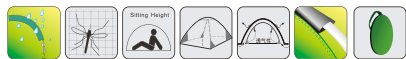
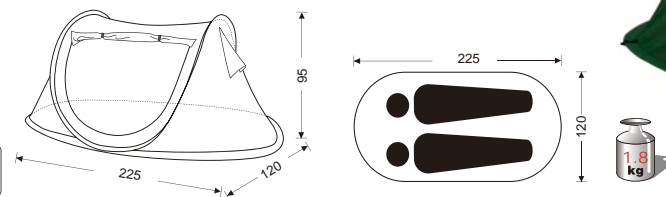

## MULTI TENT 乐活

### KT3015

产品信息：  
 搭建/包装尺寸：120x120x190cm/Φ61x3cm  
 外帐：100%聚酯纤维，KINGCAMP LEISURE防水处理  
 地席：PE 120G/M2  
 支架：6mm弹性扁钢支架  
 外袋：100%聚酯纤维，涤纶拉链提袋  
 产品特点：  
 快速打开和收起，易折叠，携带方便  
 用于营地换衣，洗澡，洗手间

Technical Specification:  
 Set/Packaged Size: 120x120x190cm/Φ61x3cm  
 Flysheet: 185T polyester oblate zipper handbag  
 Floor: PE 120G/M2  
 Pole: 6mm steel poles  
 Carry bag: 185T polyester zipper handbag  
 Easy to set up and fold up  
 Usually used as shower-toilet-changing tent

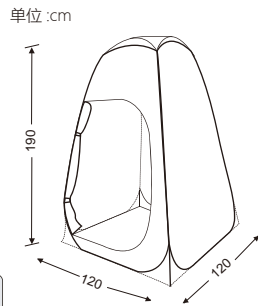

## MARASUSA 玛拉苏萨

### KT3025

产品信息：  
 搭建/包装尺寸：167x167x218m/60xΦ15cm  
 外帐：190T涤纶，PU涂层，防水1500mm  
 地席：PE 130g/m<sup>2</sup>  
 支架：铁管+玻璃纤维支架  
 外袋：150D牛津布压缩提袋  
 产品特点：  
 宽敞空间，舒适自在；  
 多种用途，洗澡、厕所、换衣等；  
 方便搭建；  
 全封闭纱网结构，防蚊虫而透气性好。

Technical Specification:  
 Set/Packaged: 167x167x218m/60xΦ15cm  
 Flysheet: 190T polyester, PU waterproof rated: 1500mm  
 Floor: PE 130g/m<sup>2</sup>  
 Pole: steel and fiberglass poles  
 Carry bag: 150D oxford waterproof compression handbag  
 Features:  
 Spacious; Multi-purpose;  
 Waterproof and breathable;  
 Easy to set up; Anti - mosquito.

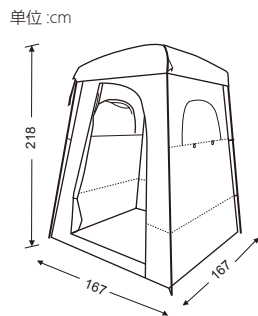

## COMPASS 凯巴斯

### KT3086

产品信息：

搭建/包装尺寸：315X215cm/60X16 X 15cm

外帐：100%聚酯纤维，KINGCAMP LEISURE防水处理

支架：3根玻璃纤维支架+2根铁支架

地钉：4根地钉；

拉绳：4根拉绳

外袋：100%聚酯纤维，涤纶拉链外袋

产品特点：

尺寸大，重量轻，易开易收，多种用途，

顶部独特泄风口设计，

用于自驾休闲旅游、野餐和遮阳。

Technical Specification:

Set/packaged size:315X215cm/60X16 X 15cm

Flysheet:210T polyester ripstop, PU waterproof rated:1500mm

Pole:fiberglass and steel poles

Carry Bag:210T polyester ripstop zipper handbag

Features:

Enough space and light weight ,easy to set up and fold up,

Multifunction uses,Special design air outlet of Body,

ideal camping and traveling.

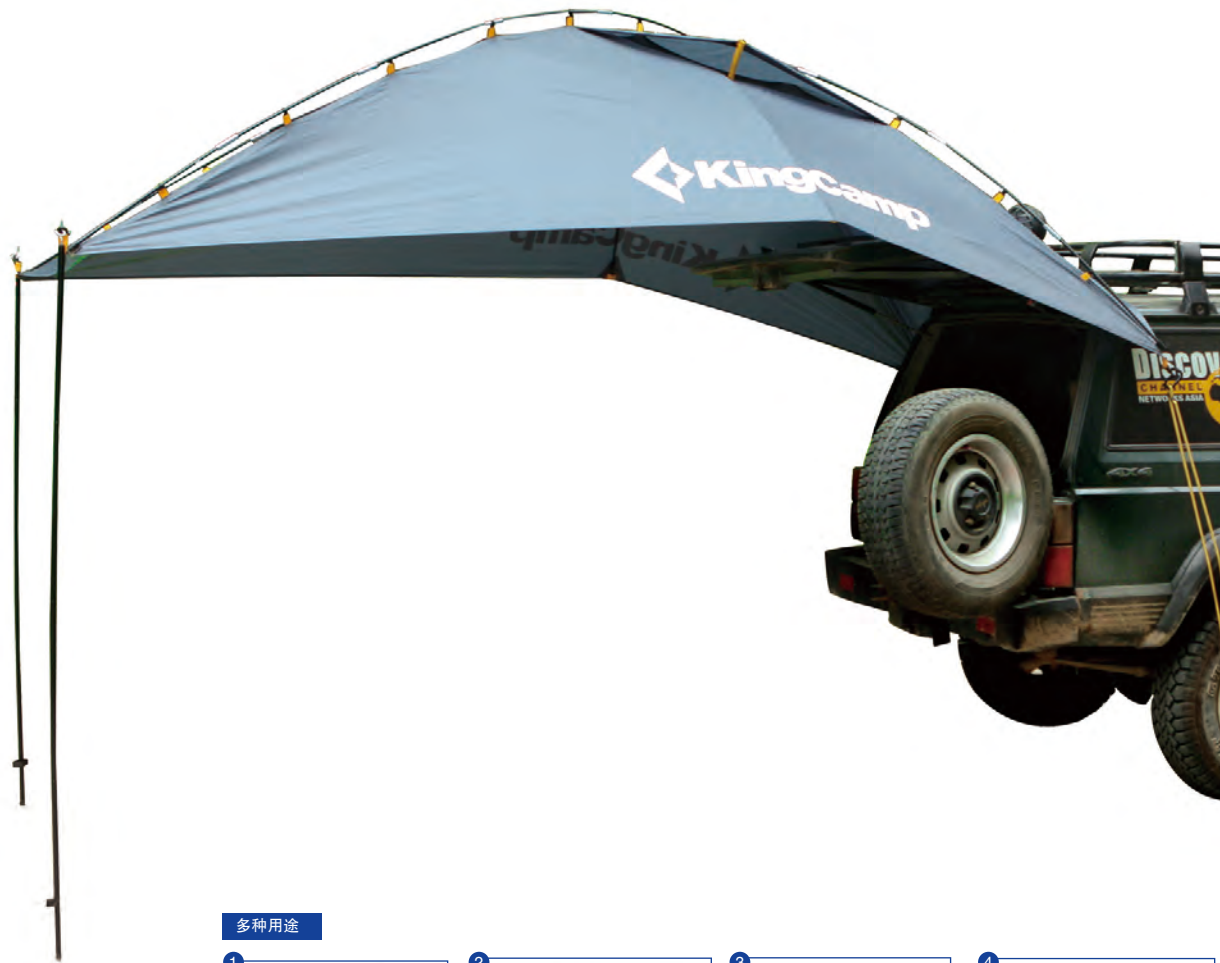

单位:cm

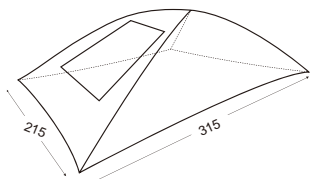

#### 多种用途





CANOPY S 小号豪华遮阳篷 KT3052

CANOPY M 中号豪华遮阳篷 KT3051

产品信息：

搭建/包装尺寸：

200x200x200(250)cm/ 120X19 X19cm ( KT3052 )

250x250x200(250)cm/ 120X20X20cm ( KT3051 )

面料：100%聚酯纤维.KINGCAMP LEISURE防水处理

支架：折叠伸缩式铁管速开支架

地钉：8根铁地钉，

拉绳：4根拉绳

外袋：100%聚酯纤维，耐磨牛津布拉链提袋

产品特点：

搭建方便简单；产品撑开后体积大，适合多人使用；

纽扣式按钮调节高度防止夹手。

顶端有泄风口，防止风大掀篷。

Technical Specification:

Set/packaged size:

200x200x200(250)cm/ 120X19X19cm(KT3052)

250x250x200(250)cm/ 120X20X20cm(KT3051)

Flysheet:210D oxford,PU waterproof rated: 1500mm

Pole:steel tubes with powder coating

Carry bag:300D oxford zipper handbag

Features:

Easy to assembly; Strong steel frame;

Button to adjust height in case of getting injured.

Big size for many persons use.



KT3052



KT3051

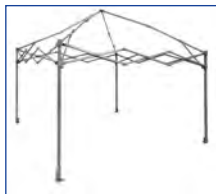



## CANOPY L

### KT3060

**产品信息：**

搭建/包装尺寸：300x300x200 ~ 250cm/ 124x20x20cm

面料：100%聚酯纤维,KINGCAMP LEISURE防水处理

支架：折叠伸缩式铁管速开支架

地钉：8根铁地钉，

拉绳：4根拉绳

外袋：100%聚酯纤维，耐磨牛津布拉链滑轮包

**产品特点：**

搭建方便简单；产品撑开后体积大，适合多人使用；

顶端有泄风口，防止风大掀篷；

PC连接铁方管支架，同时配置加粗地钉和拉绳，经久耐用；

顶部灯钩设计，可放置照明设施；

可放入带拖轮的拉杆包，方便携带和存放；

可用于庭院凉篷，商业活动，私人聚会，汽车篷等。

**Technical Specification:**

Set/packaged size:300x 300x200~250cm / 124X20X20cm

Flysheet:210D oxford,PU waterproof rated:1500mm

Pole:steel tubes with powder coating

Carry bag:300D oxford zipper wheeled handbag

**Features:**

Easy to assembly;Strong steel frame and PC connection kits;

Button to adjust height in case of getting injured.

Big size for many persons use;

Multipurpose:patio gazebo,wedding party, commercial fair shelter,and car shelter,etc.

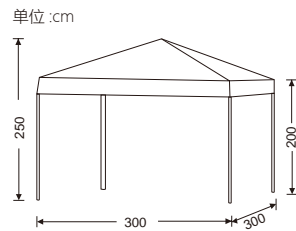





# KingCamp睡袋功能科技 KingCamp Sleeping Bags Technical Information



羽绒  
Down



仿丝棉  
Micro Loft



中空棉  
Warm Loft



四孔棉  
Super loft



Primaloft



KC化纤棉  
Comfort loft



两头通的枕头袋  
Pocket for pillow



压缩外袋  
Compression bag



双口压缩  
Double compression



普通提袋  
Stuff sac



防夹拉链条  
Zipper Baffle



Kingcamp拉链袂  
Kingcamp Zipper puller



内里口袋  
Inner Pocket



可调节魔术贴  
Adjustable Velcro



两侧固定的装置  
The ring for safe



双开双拉拉链  
2-ways Zipper



YKK拉链  
YKK Zipper



可调节领围  
Adjustable Thermo Collar



挡风墙  
Wind Baffle



加强型拉链式提袋  
Reinforced carry bag with zipper



互拼(左右或上下)  
Two pieces can be zipped together to make a double



## KingCamp 睡袋

高品质面料：所有材料都经过严格的实验室测试。超柔软精细尼龙材料，高品质羽绒、单孔棉，四孔棉、仿丝棉、Primaloft等的不同档次的面料及填充的应用，满足不同户外活动对睡袋的要求。

功能方面：

- 双开左右互拼系统
- 双层填充设计增加保暖性能，
- 外部口袋设计。
- 抽绳收纳袋、
- 两侧开口的枕头袋设计，
- 两侧固定装置。避免滚动时发生危险。

All the materials chosen to be used in the production of KingCamp Sleeping Bags are of the highest quality available in the market. Once these materials are selected they are strictly tested in our own laboratory prior to being used to produce a KingCamp Sleeping Bag.

KingCamp Sleeping Bags are built with "2 - Way Combinable Zippers" to join sleeping bags together to convert to a double sleeping bag.

All KingCamp Sleeping Bags that are filled with "White Goose Down" or "White Duck Down" have a special treatment applied "Down Proof Treatment" that prevents down leakage.

In the construction of KingCamp Sleeping Bags is a "Double Layer Filling" to keep our customers as comfortable and warm as possible. The care and attention in design and construction is evident in especially difficult outdoor weather outdoor conditions. Compared with a one layer sleeping bag at the same weight of filling, the KingCamp two layer sleeping bag is much more comfortable and warmer while bringing more protection and pleasure to the camper during outdoor travel.

## 温标范围:

KingCamp参照欧标EN-13537, 根据男女体质的不同, 科学合理地核定了每款睡袋的温标, 每款睡袋都准确地标准了3种相关温度:

- 舒适温度
- 限制温度
- 极限温度

舒适温度: 一个正常女性获得舒适睡眠的温度。

限制温度: 一个正常男性获得舒适睡眠的温度。

极限温度: 一个正常女性睡眠出现健康或者危险前的温度。

根据新的标准和标记, 在KingCamp找到一款合适的睡袋是轻而易举的事情。

## The Temperature Rating:

We scientifically rate our sleeping bags so they match the European standard (EN 13537). Our scientific method has been implemented to easily determine the temperature limit of our sleeping bags. Our new standard uses a dummy clothed in a base layer and socks to determine the actual COMFORT temperature for a good night's sleep.

We have developed a grid containing three relevant temperature ratings for every bag (comfort temperature, limit temperature for woman and men and extreme temperature):

- "COMFORT" temperature is based on a standard woman having a comfortable night's sleep (neither cold nor warm).
- "LIMIT" temperature for standard men is the lowest temperature for a standard man to have a comfortable night's sleep.
- "EXTREME" temperature is the lowest temperature before a health risk can occur for a standard women.

With these new standards and markings, finding the right bag from KingCamp has never been easier.



重量  
Weight

## TRAIL 800 KS3201

产品信息：  
 面料：100% 聚酯纤维 防撕裂格子布  
 里料：100%聚酯纤维 磨毛春亚纺  
 填充：100%聚酯纤维 70g/m2 仿丝棉 (Micro Loft)  
 外袋：100%聚酯纤维 牛津布压缩提袋  
 产品特点：  
 性价比高，可机洗。单层设计。不起静电。  
 带一个两头通的枕头袋，和抽绳收纳袋。  
 仿丝棉填充，更好的压缩。适合夏秋季节使用。

Technical Specification:  
 Outer Fabric:210T Polyester Ripstop  
 Lining:240T Poly-pouch  
 Filling:Micro Loft 70g/m2  
 Carry bag:100% Polyester 210D Oxford Compression bag  
 Features:  
 Value for money.Machine Washable.Single layer.  
 Not getting static electricity.  
 With a pocket for pillow.  
 The draw cord can be hidden in the pocket.  
 Micro fibred filling for better insulation and reduced pack size.  
 Better compression to weight ratio.

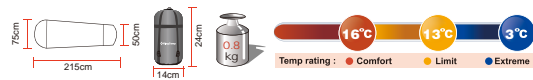

## PROTECTOR 400 KS8001 PROTECTOR 600 KS8003

产品信息：  
 面料：100%聚酯纤维；  
 里料：100%聚酯纤维；  
 填充：鸭绒 70/30 蓬松度500；  
 外袋：100%聚酯纤维 牛津布压缩提袋  
 拉链：YKK 5#双开  
 产品特点：  
 保暖性好，重量轻、易压缩、体积小。

Technical Specification:  
 Outer Fabric:100% Polyester, 50D  
 Lining:100% Polyester, 50D  
 Filling:Duck down-70/30,with 500 filling Power.  
 Carry bag:100% Polyester 210D Oxford Compression bag  
 Zippers:YKK 5# 2ways  
 Features:  
 Light,easy to compress,  
 reduced pack size and keep warm well.

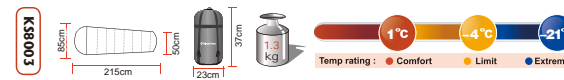
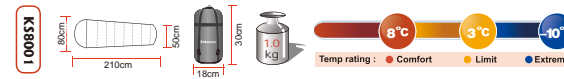

## FAVOURER 450 MIX KS8018

产品信息：  
 面料：100%聚酯纤维；  
 里料：100%聚酯纤维；  
 填充：鸭绒 70/30,蓬松度500  
 100%聚酯纤维0.7D超细防鹅绒棉  
 外袋：100%聚酯纤维 牛津布压缩提袋  
 拉链：YKK 5#双开  
 产品特点：  
 下片超细防鹅绒棉填充，防潮吸湿，  
 上片高品质鸭绒填充，保暖性好，  
 整体重量轻、易压缩、体积小。

Technical Specification:  
 Outer Fabric:100% Polyester, 50D  
 Lining:100% Polyester, 50D  
 Filling:Duck down-70/30,with 500 filling Power  
 0.7D anti-goose Micro Loft 50g/m2  
 Carry bag:100% Polyester 210D Oxford Compression bag  
 Zippers:YKK 5# 2ways  
 Features:  
 Showings superfine cotton anti goose down filling,  
 moisture absorption,  
 Poorly at high quality duck down filling,warm and good,  
 Overall light weight,easy to compress,small size.

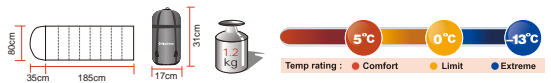

## FAVOURER 425 KS8004 FAVOURER 600 KS8006

产品信息：  
 面料：100%聚酯纤维；  
 里料：100%聚酯纤维；  
 填充：鸭绒 70/30,蓬松度500；  
 外袋：100%聚酯纤维 牛津布压缩提袋  
 拉链：YKK 5#双开  
 产品特点：  
 保暖性好，重量轻、易压缩、体积小。

Technical Specification:  
 Outer Fabric:100% Polyester, 50D  
 Lining:100% Polyester, 50D  
 Filling:Duck down-70/30,with 500 filling Power.  
 Carry bag:100% Polyester 210D Oxford Compression bag  
 Zippers:YKK 5# 2ways  
 Features:  
 Light,easy to compress,  
 reduced pack size and keep warm well.

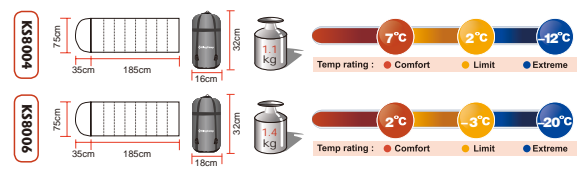



**FAVOURER 700D KS8016**  
**FAVOURER 900D KS8017**

产品信息:  
 产品信息:  
 面料: 100%聚酯纤维;  
 里料: 100%聚酯纤维;  
 填充: 鸭绒 70/30, 蓬松度500  
 外袋: 100%聚酯纤维 牛津布压缩提袋  
 拉链: YKK 5#双开  
 产品特点:  
 高品质鸭绒填充, 保暖性好,  
 重量轻、易压缩、体积小,  
 帽子可拆卸, 多种用途。

Technical Specification:  
 Outer Fabric: 100% Polyester, 50D  
 Lining: 100% Polyester, 50D  
 Filling: Duck down-70/30, with 500 filling Power.  
 Carry bag: 100% Polyester 210D Oxford Compression bag  
 Zippers: YKK 5# 2ways  
 Features:  
 High quality duck down filling,  
 warm and good, Light weight,  
 easy to compress, small size,  
 Removable hat, a variety of purposes.

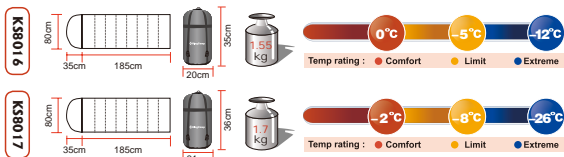

**DEFENDER 600**  
**KS8019**

产品信息:  
 面料: 100%聚酯纤维;  
 里料: 100%聚酯纤维;  
 填充: 鸭绒 80/20, 蓬松度550  
 外袋: 100%聚酯纤维 牛津布压缩提袋  
 拉链: YKK 5#双开  
 产品特点:  
 高品质鸭绒填充, 防潮吸湿, 保暖性好,  
 重量轻、易压缩、体积小, 色彩艳丽, 超强时尚感。

Technical Specification:  
 Outer Fabric: 100% Polyester, 50D  
 Lining: 100% Polyester, 50D  
 Filling: Duck down-80/20, with 550 filling Power  
 Carry bag: 100% Polyester 210D Oxford Compression bag  
 Zippers: YKK 5# 2ways  
 Features:  
 High quality duck down filled,  
 moisture absorption, warm and good,  
 Light weight, easy to compress,  
 small, colorful, super stylish.

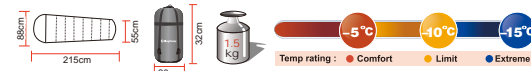

## ACTIVE 250 KS3202

### 产品信息：

面料：100% 聚酯纤维防撕裂 格子布  
 里料：舒适全棉法兰绒  
 填充：100%聚酯纤维 250g/m2, 中空棉(Warm Loft)  
 提袋：100%聚酯纤维 牛津布压缩提袋  
 外袋：100%聚酯纤维 牛津布压缩提袋  
 产品特点：  
 性价比高；全棉法兰绒，提供超级舒适的感觉；  
 方便身体在睡袋内部的转动；方便压缩，体积小；  
 纤维棉填充，可以减小包装尺寸；  
 两件可以拼装成双人睡袋，增加舒适程度。

### Technical Specification:

Outer Fabric:210T Polyester Ripstop W/P  
 Lining:100% cotton Flannel  
 Filling:Warm Loft 250g/m2  
 Carry bag:100% Polyester 210D Oxford Compression bag  
 Features:  
 Value for money.  
 The 100% cotton flannel lining provides extreme comfort and softness against the skin.  
 Flannel return flap allows easier movements.  
 Hollow fibred filling for better insulation and reduced pack size.  
 Two pieces can be zipped together to make a double and incorporates Comfort Sleep System.

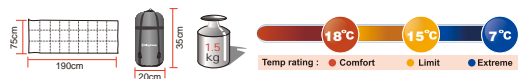
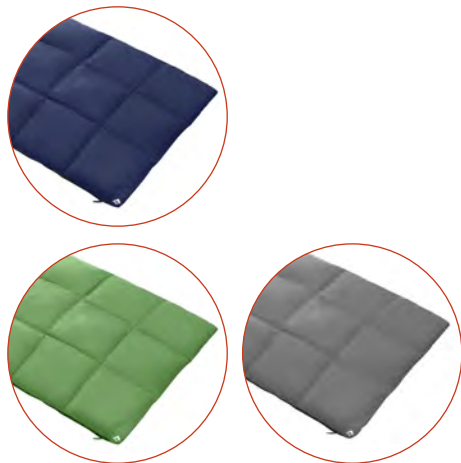

## CAMPER 250 KS3204

### 产品信息：

面料：100%聚酯纤维 防撕裂格子布  
 里料：全棉法兰绒材料  
 填充：100%聚酯纤维 250g/m2 中空棉(Warm Loft)  
 外袋：100%聚酯纤维 牛津布压缩提袋  
 产品特点：  
 性价比高；全棉法兰绒，提供超级舒适的感觉；  
 方便身体在睡袋内部的转动；枕头可以拆卸；  
 便压缩，体积小；纤维棉填充，可以减小包装尺寸；  
 两件可以拼装成双人睡袋，增加舒适程度。

### Technical Specification:

Outer Fabric:100% Polyester Rip stop 210T  
 Lining:100% cotton Flannel  
 Filling:100% Polyester Warm Loft 250g/m2  
 Carry bag:100% Polyester 210D Oxford Compression bag  
 Features:  
 Value for money.  
 The 100% cotton flannel lining provides extreme comfort and softness against the skin.  
 Flannel return flap allows easier movements.  
 Hollow fibred filling for better insulation and reduced pack size.  
 With the pillow can be parted.  
 Two pieces can be zipped together to make a double and incorporates Comfort Sleep System.

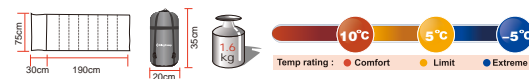

## PREMIUM 350 KS3205



产品信息：  
 面料：100%聚酯纤维 防撕裂格子布  
 里料：100%聚酯纤维 磨毛春亚纺  
 填充：100%聚酯纤维 350g/m2 中孔棉(Warm Loft)  
 外袋：100%聚酯纤维 牛津布压缩提袋  
 产品特点：  
 性价比高。加宽尺寸，方便身体在睡袋内部的转动。  
 附赠枕头。方便压缩，体积小。  
 纤维棉填充，可以减小包装尺寸。  
 两件可以拼装成双人睡袋，增加舒适程度。

Technical Specification:  
 Outer Fabric:100% Polyester Rip stop 210T  
 Lining:100% Polyester 210T Poly-pouch  
 Filling:100% Polyester Warm Loft 350g/m2  
 Carry bag:100% Polyester 210D Oxford Compression bag  
 Features:  
 Value for money.  
 Hollow fibred filling for better insulation  
 and reduced pack size.  
 With the additional pillow.  
 Two pieces can be zipped together to make a double and  
 incorporates Comfort Sleep System.

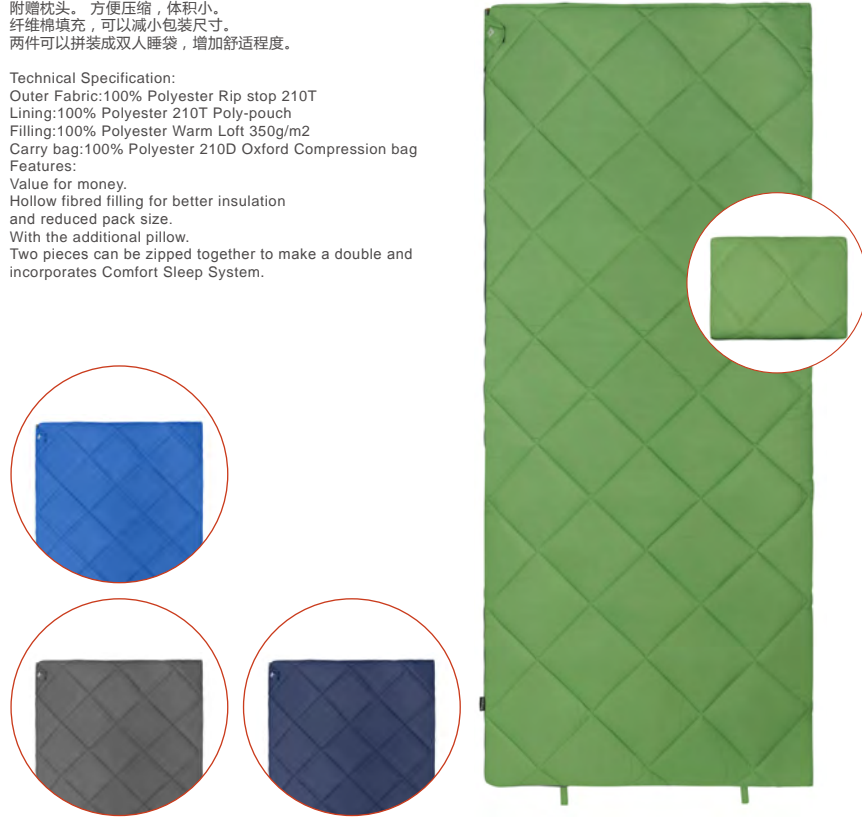

## DESERT 250 KS3206 DESERT 350 KS3207



产品信息：  
 面料：100%聚酯纤维 防撕裂格子布  
 里料：100%聚酯纤维 磨毛春亚纺  
 填充：100%聚酯纤维 250g/m<sup>2</sup> 中孔棉(Warm Loft) (KS3205)  
 100%聚酯纤维 2×175g/m<sup>2</sup> 中孔棉(Warm Loft) (KS3206)  
 外袋：100%聚酯纤维 牛津布压缩提袋  
 产品特点：  
 高性价比；不起静电；  
 有帽檐、防夹拉链条、挡风墙、胸领，内口袋设计。

Technical Specification:  
 Outer Fabric: 100% Polyester Rip stop 210T  
 Lining:100% Polyester 210T Poly-pouch  
 Filling:100% Polyester warm loft 250g/m<sup>2</sup> (KS3205)  
 100% Polyester warm loft 2×175g/m<sup>2</sup> (KS3206)  
 Carry bag:100% Polyester 210D Oxford Compression bag  
 Features:  
 Value for money.  
 Warm loft filling for better insulation and  
 reduced pack size.  
 Better compression to weight ratio.

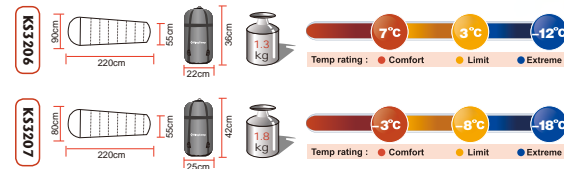



## MOUNTAIN 320 KS3208

产品信息：  
 面料:100%聚酯纤维 防撕裂格子布  
 里料：100%聚酯纤维 磨毛春亚纺  
 填充：100%聚酯纤维 2×160g/m<sup>2</sup> 中空棉(Warm Loft)  
 外袋：100%聚酯纤维 牛津布压缩提袋

产品特点：  
 防撕裂面料，结实耐用；  
 双层填充，保暖性好；  
 压缩外袋，方便携带；  
 胸领/内口袋/桶型脚底设计。

Technical Specification:  
 Outer Fabric: 100% Polyester Rip stop 210T  
 Lining:100% Polyester 210T Poly-pouch  
 Filling:100% Polyester warm loft 2×160g/m<sup>2</sup>  
 Carry bag:100% Polyester 210D Oxford Compression bag  
 Features:  
 Value for money.  
 Warm loft filling for better insulation and reduced pack size.  
 Better compression to weight ratio.

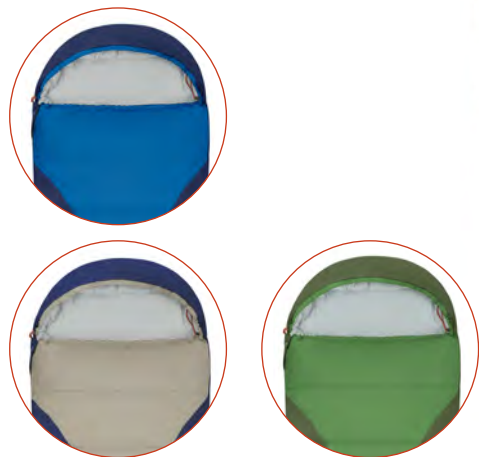

## COMFORT 280S KS3127 COMFORT 280 KS3128 COMFORT 280D KS3129

产品信息：  
 面料: 65%聚酯纤维 35%棉  
 里料: 全棉法兰绒  
 填充: 100%聚酯纤维 2 × 140g/m<sup>2</sup>中空棉  
 外袋: 100%聚酯纤维 牛津布压缩提袋

产品特点：  
 柔软涤棉面料以及全棉法兰绒里料，  
 提供皮肤舒适触觉；  
 双层填充工艺，更保暖；  
 枕头套附带充棉枕头设计，提升体验舒适度。

Technical Specification:  
 Outer Fabric:T/C,65% Polyester, 35% cotton  
 Lining:100% cotton Flannel  
 Filling:100% Polyester Warm Loft 2x140g/m<sup>2</sup>  
 Carry bag:100% Polyester 210D Oxford compression bag  
 Features:  
 Dual layer offset stitching eliminates cold spots.  
 the skin.100% Cotton Flannel lining surrounds your body  
 with softness and warm.  
 Adjustable drawstring half-circle mummy hood keeps heads  
 or pillows off the ground and helps lock in heat.

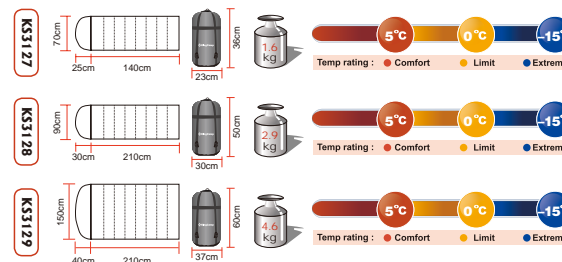

**FOREST 400 KS3152**  
**FOREST 500 KS3153**  
**FOREST 600L KS3154**

产品信息：  
 面料: 100%棉 纱卡布  
 里料: 100%棉 法兰绒  
 内胆: 100%聚酯纤维 摇粒绒  
 填充: 100%聚酯纤维 400g/m2中空棉 (KS3152)  
 100%聚酯纤维 400g/m2中空棉 (KS3153)  
 100%聚酯纤维 600g/m2中空棉 (KS3154)  
 外袋: 100%聚酯纤维 牛津布提袋  
 产品特点：  
 拉链式可拆卸抓绒内胆设计，方便清洗以及调节舒适温暖；  
 全棉纱卡面料以及全棉法兰绒里料运用，完美平衡舒适性和耐用性；  
 拆卸式半圆头帽附带枕头设计，保证户外露营的舒适享受；  
 大尺寸拉链旅行包式外袋设计，方便收纳携带。

Technical Specification:  
 Outer Fabric:100% Cotton Khaki  
 Lining:100% Cotton Flannel  
 Liner:100% Polyester Fleece  
 Filling:100% Polyester Warm Loft 400g/m2(KS3152)  
 100% Polyester Warm Loft 500g/m2(KS3153)  
 100% Polyester Warm Loft 600g/m2(KS3154)  
 Carry bag:100% Polyester 210D Oxford zippered handbag  
 Features:  
 Removable zippered fleece liner for easy to clean and adjust temperature .  
 Removable zippered half-circle Headrest for fully open to be used as a quilt keeps heads or pillows off the ground and helps lock in heat.  
 Portable and space-saving, easy to roll up into the zippered handbag.

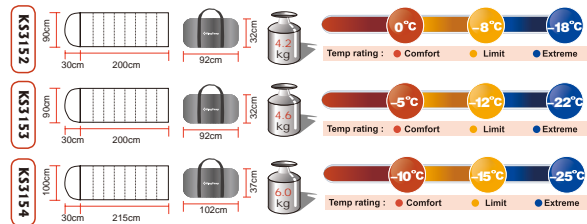

**PRAIRIE 300 KS3209**



产品信息：  
 面料:100%聚酯纤维 防撕裂格子布  
 里料：全棉法兰绒  
 填充：100%聚酯纤维 300g/m<sup>2</sup> 化纤棉(Warm Loft)  
 外袋：100%聚酯纤维 牛津布压缩提袋  
 产品特点：  
 防撕裂面料，结实耐用；  
 全棉法兰绒里料，舒适保暖；  
 压缩外袋，方便携带；加宽尺寸设计。

Technical Specification:  
 Outer Fabric:100% Polyester Rip stop, 210T  
 Lining:100% Cotton Flannel  
 Filling:100%Polyester 300g/m<sup>2</sup> Comfot soft Carry Bag:210D Oxford Compression Bag  
 Features:  
 100% cotton flannel lining provides extreme comfort and softness against the skin.  
 Better compression to weight ratio.

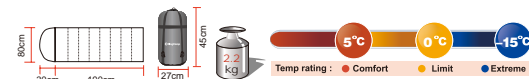

## CHAMPAIGN 250 KS3210



产品信息：  
 面料：100%聚酯纤维 防撕裂格子布  
 里料：100%聚酯纤维  
 填充：100%聚酯纤维 250g/m<sup>2</sup> 化纤棉(Warm Loft)  
 外袋：100%聚酯纤维 牛津布压缩提袋  
 产品特点：  
 防撕裂面料，结实耐用；  
 脱壳工艺，更保温；压缩外袋，  
 方便携带；加宽尺寸设计。

Technical Specification:  
 Outer Fabric: 100% Polyester Rip stop, 210T  
 Lining: 100% Polyester  
 Filling: 100% Polyester 250g/m<sup>2</sup> Comfort soft  
 Carry Bag: 210D Oxford Compression Bag  
 Features:  
 Adjustable drawstring half-circle mummy hood keeps heads or pillows off the ground and helps lock in heat. Better compression to weight ratio.

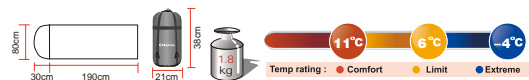
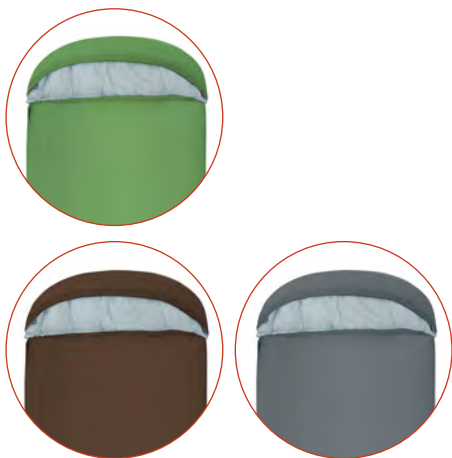

## VALLEY 330 KS3211



产品信息：  
 面料：100%聚酯纤维 防撕裂格子布  
 里料：100%聚酯纤维  
 填充：100%聚酯纤维 330g/m<sup>2</sup> 化纤棉(Warm Loft)  
 外袋：100%聚酯纤维 牛津布压缩提袋  
 产品特点：  
 可拼接设计；  
 防撕裂面料，结实耐用；  
 压缩外袋，方便携带；  
 加宽尺寸设计。

Technical Specification:  
 Outer Fabric: 100% Polyester Rip stop, 210T  
 Lining: 100% Polyester  
 Filling: 100% Polyester 330g/m<sup>2</sup> Comfort soft  
 Carry Bag: 210D Oxford Compression Bag  
 Features:  
 Two pieces can be zipped together to make a double and incorporates Comfort Sleep System. Better compression to weight ratio.

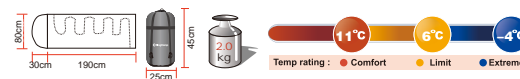
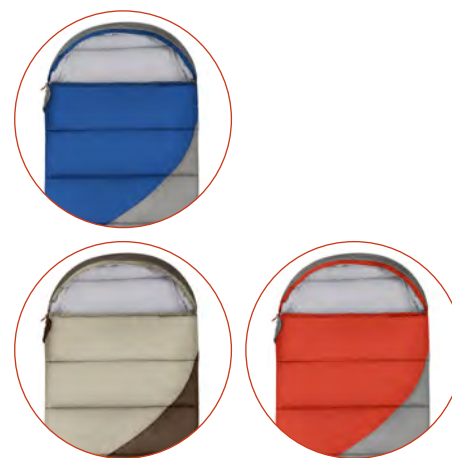



## AIRBED SLEEPING BAG 250D KS3139

### 产品信息：

面料: 100%聚酯纤维 防水压光处理

里料: 100%棉法兰绒

底料: 65%聚酯纤维 35%棉

填充: 100%聚酯纤维 Warm Loft 250g/m<sup>2</sup> (上片)  
100%聚酯纤维 Warm Loft 140g/m<sup>2</sup> (下片)

外袋: 100%聚酯纤维 牛津布压缩提袋

### 产品特点：

搭配固定通用双人充气床，提供完美户外居家睡眠解决方案；

上片可单独作为单人睡袋使用；

左右两侧拉链设计，方便进出睡袋；

睡袋脚部拱形设计，给脚充足的活动空间；

两侧纱网兜设计，方便放置随身小件物品。

### Technical Specification:

Outer Fabric:100% Polyester 190T w/p Cire

Lining:100% cotton Flannel

Bottom Fabric:T/C, 65% Polyester 35% cotton

Filling:100% Polyester Warm Loft 250g/m<sup>2</sup> (Top)

100% Polyester Warm Loft 140g/m<sup>2</sup> (Bottom)

Carry Bag:100% Polyeste 210D Oxford Compression Bag

### Features:

Top half can be used as a stand-alone lightweight sleeping bag.

Fitted sheet-style bottom fits over a full or queen size airbed.

Zippers on both sides to get in and out without waking up your partner and controlling the temperature on each side.

Two side mesh storage pockets to hold flashlight, wallet, keys, watch and other valuables.

Body mapping with warmer vaulted foot-box provides added warmth and comfort for toes even in freezing conditions.



**STANDING 250S KS3140**  
**STANDING 250M KS3141**  
**STANDING 250L KS3142**

产品信息:  
 面料: 100%聚酯纤维  
 里料: 100%聚酯纤维  
 填充: 100%聚酯纤维  
 外袋: 100%聚酯纤维 牛津布压缩提袋  
 产品特点:  
 可穿型人体睡袋, 完全比照人体外观设计,  
 保暖性好, 便于活动;  
 胸前双侧拉链设计, 便于穿脱;  
 手部拉链口以及脚部可拆卸拉链结构,  
 解放手脚, 活动自如。

Technical Specification:  
 Outer Fabric: 100% Polyester 190T w/p cire  
 Lining: 100% Polyester  
 Filling: 100% Polyester warm loft 250G/M2;  
 Carry bag: 100% Polyester 210D Oxford Compression bag  
 Features:  
 Double front entry-zippers make for quick entry and exit.  
 Zipper closure system on the sleeves allow you to keep your hands free to do stuff.  
 Zipper closure system with 600D Oxford bottom on the feet for extra ventilation on warmer nights and better Durability.

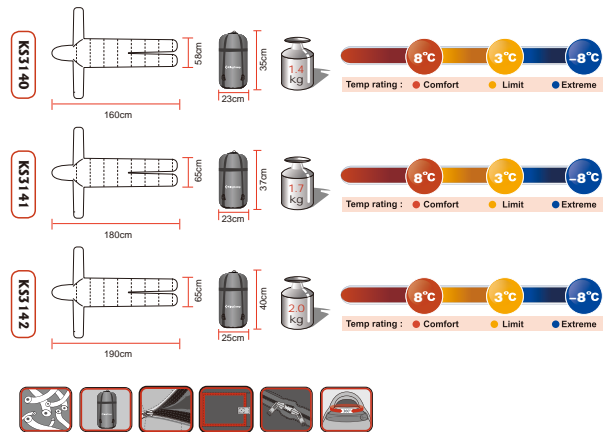

## FREESPACE 250 KS3168

产品信息：  
 面料：100%聚酯纤维 防水压光处理  
 里料：100%棉法兰绒  
 填充：100%聚酯纤维 250g/m2 中空棉  
 外袋：100%聚酯纤维 牛津布压缩提袋  
 产品特点：  
 全棉法兰绒里料保证产品良好的舒适性；  
 太空舱式的设计，给使用者更大的活动空间；  
 两侧的固定装置保证使用者的安全；  
 抽绳调节式头帽结构，保证头部温暖舒适；  
 胸领以及拉链挡风条结构提升保暖性能。

Technical Specification:  
 Outer Fabric: 100% Polyester 190T w/p cure  
 Lining: 100% Cotton Flannel  
 Filling: 100% Polyester Warm Loft 250g/m2  
 Carry bag: 100% Polyester 210D Oxford Compression bag  
 Features:  
 Oversized sleeping bag provides roomy, comfy night's sleep for campers of all shapes and sizes.  
 Adjustable drawstring half-circle mummy hood keeps heads or pillows off the ground and helps lock in heat.  
 Insulated chest baffle holds heat in the body of the bag.

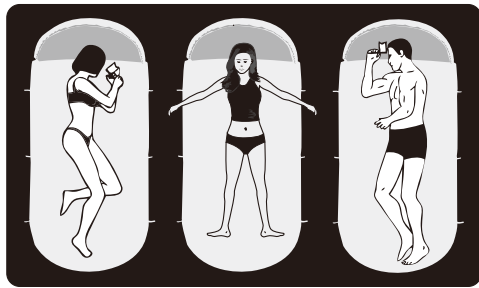



- TRECK 125 **KS3190**
- TRECK 200 **KS3191**
- TRECK 250 **KS3192**
- TRECK 300 **KS3131**
- TRECK 450L **KS3193**

产品信息：

面料：100%聚酯纤维，防水、压光处理  
 里料：100%聚酯纤维 磨毛春亚纺  
 填充：100%聚酯纤维 125g/m2 中空棉(Warm Loft) (KS3190)  
 100%聚酯纤维 200g/m2 中空棉(Warm Loft) (KS3191)  
 100%聚酯纤维 250g/m2 中空棉(Warm Loft) (KS3192)  
 100%聚酯纤维 2×150g/m2 中空棉(Warm Loft) (KS3131)  
 100%聚酯纤维 2×225g/m2 中空棉(Warm Loft) (KS3193)

外袋：100%聚酯纤维 牛津布压缩提袋

产品特点：

性价比高。即使在潮湿的环境中也能很好的保暖。  
 中空棉填充，更好的压缩和保暖。增加了抽绳收纳袋。  
 超大尺寸，更加舒适。增加了抽绳收纳袋，超大尺寸，更加舒适。

Technical Specification:

Outer Fabric: 190T Polyester W/P Cire  
 Lining: 100% Polyester 240T Poly-pouch  
 Filling: Warm Loft 125g/m2 (KS3190)  
 Warm Loft 200g/m2 (KS3191)  
 Warm Loft 250g/m2 (KS3192)  
 Warm Loft 2×150g/m2 (KS3131)  
 Warm Loft 2×225g/m2 (KS3193)

Carry bag: 100% Polyester 210D Oxford Compression bag

Features:

Double layer. Keep warm well even under damp environment.  
 Hollow fibred filling for better insulation and reduced pack size.  
 Hood, Wind Baffle, Zipper Baffle, Collar, Inner Pocket, With a pocket for pillow. The draw cord can be hidden in the pocket.  
 Better compression to weight ratio.

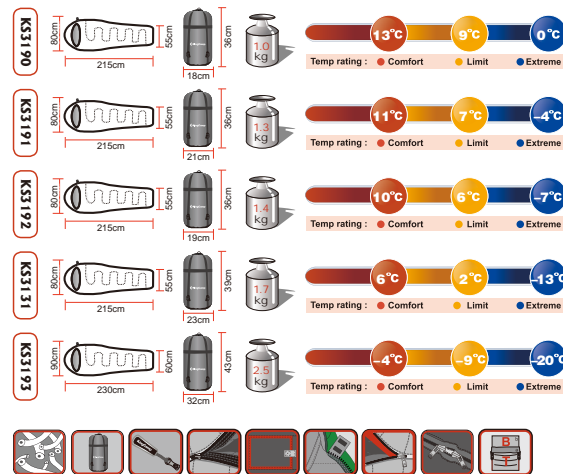

OASIS200 **KS8014**  
 OASIS 250 **KS3121**  
 OASIS 250+ **KS8015**  
 OASIS 300 **KS3155**

产品信息：

面料：100%聚酯纤维，防水、压光处理

里料：100%聚酯纤维 (KS8014/KS3121/KS3151)

全棉法兰绒格子布 (KS8015)

填充：100%聚酯纤维200g/m2 Comfort Loft (KS8014)

100%聚酯纤维250g/m2 Comfort Loft (KS3121/ KS8015)

100%聚酯纤维2×150g/m2 Comfort Loft (KS3155)

外袋：100%聚酯纤维 牛津布压缩提袋

产品特点：

重量轻，方便压缩，保暖性好。单层设计。

帽檐、胸领、挡风墙、内袋、防夹拉链条。

Technical Specification:

Outer Fabric: 190T Polyester w /p cire

Lining:100%Polyester

Filling:Comfort Loft 200g/m2 (KS8014)

Comfort Loft 250g/m2 (KS3121/ KS8015)

Comfort Loft 2×150g/m2 (KS3155)

Carry bag: 100% Polyester 210D Oxford Compression bag

Features:

Light weight.Easy to compress and keep warm well.

Single layer.Hood, Thermo Collar,

Wind Baffle Inner Pocket, Zipper Baffle.

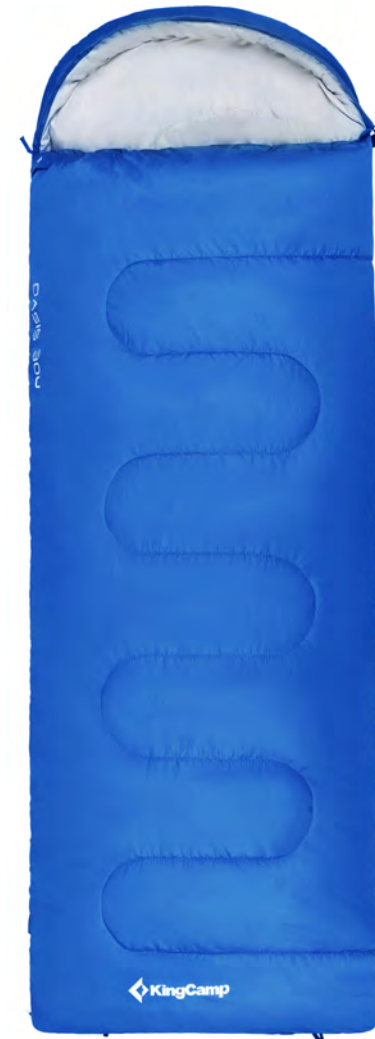
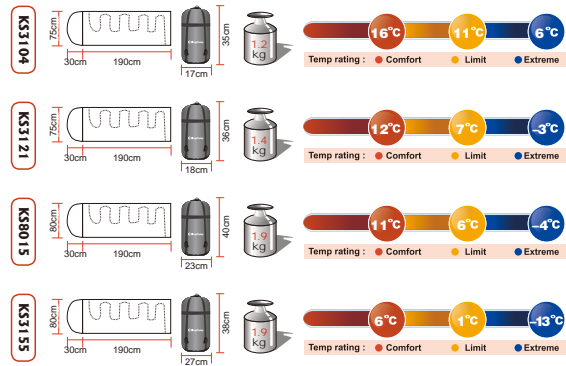

- OXYGEN 200M **KS3122**
- OXYGEN 300 **KS3144**
- OXYGEN 300L **KS3145**
- OXYGEN 300XL **KS3146**
- OXYGEN 250D **KS3143**

产品信息：

面料：100%聚酯纤维，防水、压光处理  
 里料：100%聚酯纤维  
 填充：100%聚酯纤维200g/m2 Comfort Loft (KS3122)  
 100%聚酯纤维250g/m2 Comfort Loft (KS3143)  
 100%聚酯纤维300g/m2 Comfort Loft (KS3144/KS3145/KS3146)  
 外袋：100%聚酯纤维 涤纶收口袋 (KS3122)  
 100%聚酯纤维 牛津布压缩袋(KS3143/KS3144/KS3145/KS3146)

产品特点：

经典系列，高性价比；  
 填充中空棉，保暖性好，更容易压缩和携带；  
 单人款双人款可相互转换，增强适用性。

Technical Specification:

Outer Fabric:190T Polyester w /p cire  
 Lining:100%Polyester  
 Filling: 100%Polyester 200g/m2 Comfort Loft (KS3122)  
 100%Polyester 250g/m2 Comfort Loft (KS3143)  
 100%Polyester 300g/m2 Comfort Loft (KS3144/KS3145/KS3146)  
 Carry bag:100% Polyester 190T stuff bag (KS3122)  
 100% Polyester 210D Oxford Compression bag (KS3143/KS3144/KS3145/KS3146)

Features:

Comfort and warm. Value for money.  
 Hollow fibred filling for better insulation and reduced pack size.  
 2 Bags can be zipped together to make a double and incorporates  
 Comfort Sleep System.

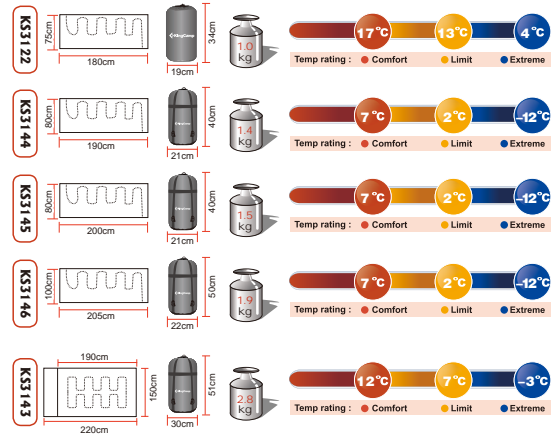



**JUNIOR B KS3194**  
**JUNIOR G KS3195**

产品信息：  
面料:100%聚酯纤维 防水压光处理  
里料: 舒适全棉法兰绒  
填充: 100%聚酯纤维 200g/m2中空棉(Warm Loft)  
外袋: 100%聚酯纤维 牛津布压缩提袋  
产品特点: 性价比高。  
柔软的面料和里料保证产品良好的舒适性。单层设计。  
中空棉填充，易压缩，方便携带。增加抽绳收纳袋设计。

Technical Specification:  
Outer Fabric: 190T Polyester w/p cire  
Filling: Warm Loft 200g/m2  
Lining: 100% Cotton  
Carry bag: 100% Polyester 210D Oxford Compression bag  
Features: Value for money.  
Machine Washable. Single layer.  
Soft shell & cotton lining make the sleep more comfort.  
Hollow fibred filling for better insulation and reduced pack size.  
The draw cord can be hidden in the pocket.

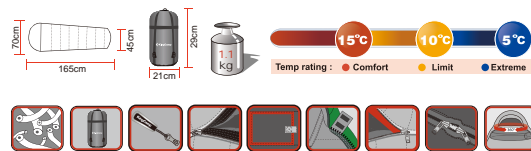

**JUNIOR 200 KS3130**

产品信息：  
面料: 100%聚酯纤维，防水、压光处理  
里料: 100%聚酯纤维  
填充: 100%聚酯纤维 Comfort Loft 200g/m<sup>2</sup>  
外袋: 100%聚酯纤维 耐磨牛津布  
产品特点：  
中空棉填充更容易压缩和携带；  
背包式外袋，方便携带；  
左右2件产品可以合并成双人睡袋。

Technical Specification:  
Outer Fabric: 190T Polyester W/P Cire  
Lining: 100% Polyester  
Filling: 100% Polyester Comfort Loft 200g/m<sup>2</sup>  
Carry bag: 100% Polyester 210D Oxford backpack  
Features:  
Hollow fibred filling for better insulation and reduced pack size. 2 Bags can be zipped together to make a double and incorporates Comfort Sleep System. Unzip the bottom for extra ventilation on warmer nights.

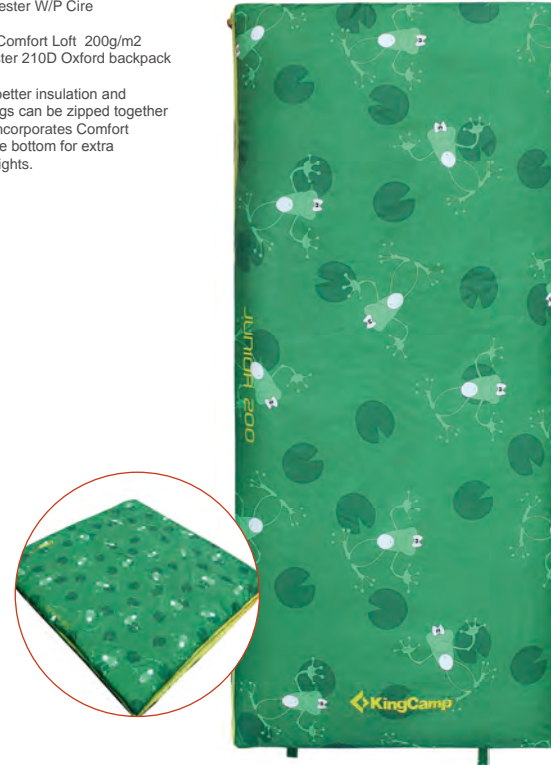







## KingCamp垫子功能科技 KingCamp Mattress Technical Information



**修补包**  
Repair kit



**防滑底**  
Non-slipped



**内部脚踏气泵**  
Built in Pump



**对折**  
Fold



**卷装**  
Roll



**PVC透明安全气嘴**  
PVC Safe valve



**彩盒包装**  
Packing in color box



**波士顿螺旋气嘴**  
Boston valve



**重量**  
Weight



**左右互拼**  
Two pieces can be make to double



**铜气嘴加工程塑料帽保护**  
Bronze + Plastic Cover valve



**大的塑料气嘴**  
Bigger Plastic valve



**牛津布袋 (方形或圆柱形)**  
210D oxford bag



### 菱形竖打孔

高倍进口超轻海绵，重量和压缩体积可以减轻30%

Die-cut Matrix Foam  
Weight 30% less! Matrix Foam built for weight conscious trekkers. Open cell foam The die-cut Matrix Foam provides outstanding insulation and minimum weight.

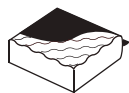

### 波浪表面

高倍进口海绵，很好的绝缘功能，使睡眠更加舒适

Wave foam  
Maximum insulation & comfort. Solid open cell foam. The die-cut Wave Foam provides outstanding insulation and maximum comfort.



### 平板表面

高倍进口海绵，非常舒适、绝缘、耐用

Warm Foam  
Solid comfort, insulation and durability Solid open cell foam. Provides the best support, comfort and insulation.

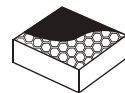

### 蜂巢表面

高倍进口海绵，很好的按摩效果，柔软度较好、耐用、舒适

Honeycomb Foam  
High Quality Spone, Massage Effect Maximum Comfort and Safcness

## KingCamp 垫子

Kingcamp拥有全系列的垫子产品，从最经济型的EVA垫子到专业登山的自动充气垫，每一类产品都体现了kingcamp品牌的独特性。Kingcamp拥有最全的充气垫子系列，从适合背包一族的超轻系列到适合露营休闲使用的棉布橡胶系列，以及性价比高，用途广泛的植绒系列，不同层面的消费者都可以在kingcamp找到适合自己的款式。

### Description Summary

KingCamp has a diverse range of self-inflating, flock and cotton mattresses which offer our customers a choice of performance products. From technical lightweight styles to luxurious deep fill mattresses, there is one to suit everyone. With upgrades and new items this is a fantastic range for the 2013 camping season. Utilizing the most advanced joint and sponge equipment, KingCamp mats excel in the self-inflating mat category producing world class products.



**CLASSIC LIGHT KM3595**  
**CLASSIC COMFORT KM3596**  
**CLASSIC SUPER KM3597**

产品信息：  
 上部面料：100%聚酯纤维 150D牛津布贴合PVC  
 底部面料：100%聚酯纤维 150D牛津布贴合PVC  
 气嘴：铜气嘴加工程塑料保护帽  
 外袋：100%聚酯纤维 牛津布收口袋  
 产品特点：  
 内置自充气海绵枕设计，提供舒适睡眠；  
 波浪表面处理开孔海绵，快速充气放气，保持舒适；  
 铜气嘴设计，使用方便，寿命更长；  
 附赠收纳外袋、弹力捆扎织带以及修补包

Technical Specification:  
 TOP Fabric:100%Polyester 150D Oxford PVC coating  
 Bottom Fabric:100%Polyester 150D Oxford PVC coating  
 Valve:Brass with plastic map  
 Carry bag:150D Oxford stuff sack  
 Features:  
 Built-in self-inflatable foam sponge pillow for comfort;  
 Jet Stream Wave Open Cell Foam;  
 Free-flowing, non-corrosive brass valve;  
 included an oversized carrying bag ,  
 compression straps and Repair Kit.

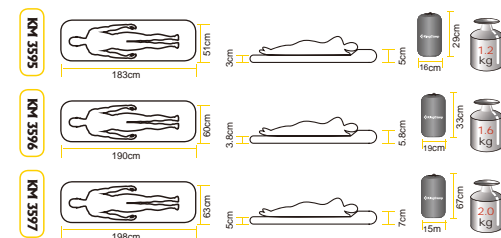

**CLASSIC DOUBLE KM3538**

产品信息：  
 上部面料：100%聚酯纤维 150D牛津布贴合PVC  
 底部面料：100%聚酯纤维 150D牛津布贴合PVC  
 气嘴：铜气嘴加工程塑料保护帽  
 外袋：100%聚酯纤维 牛津布收口袋  
 产品特点：  
 居中折痕设计，可对折成加厚单人自充垫使用；  
 波浪表面处理开孔海绵，快速充气放气，保持舒适；  
 双铜气嘴设计，使用方便，寿命更长；  
 附赠收纳外袋、弹力捆扎织带以及修补包

Technical Specification:  
 TOP Fabric: 100%Polyester 150D Oxford PVC coating  
 Bottom Fabric:100%Polyester 150D Oxford PVC coating  
 Valve: Brass with plastic map  
 Carry bag: 150D Oxford stuff sack  
 Features:  
 Jet Stream Wave Open Cell Foam;  
 Two free-flowing, non-corrosive brass valve;  
 included an oversized carrying bag ,  
 compression straps and Repair Kit.



**DELUXE SINGLE KM3584**  
**DELUXE PLUS KM3585**  
**DELUXE WIDE KM3586**  
**DELUXE DOUBLE KM3587**

产品信息：  
 上部面料：100%聚酯纤维 150D牛津布贴合PVC  
 底部面料：100%聚酯纤维 150D牛津布贴合PVC  
 气嘴：铜气嘴加工程塑料保护帽  
 外袋：100%聚酯纤维 150D牛津布收口袋

产品特点：  
 波浪表面处理开孔海绵，快速充气放气，保持舒适；  
 双铜气嘴设计，使用方便，寿命更长；  
 附赠收纳外袋、弹力捆扎织带以及修补包

Technical Specification:  
 TOP Fabric:100%Polyester 150D Oxford PVC coating  
 Bottom Fabric:100%Polyester 150D Oxford PVC coating  
 Valve:Brass with plastic map  
 Carry bag:150D Oxford stuff sack  
 Features:  
 Jet Stream Wave Open Cell Foam;  
 Two free-flowing, non-corrosive brass valve;  
 included an oversized carrying bag ,  
 compression straps and Repair Kit.

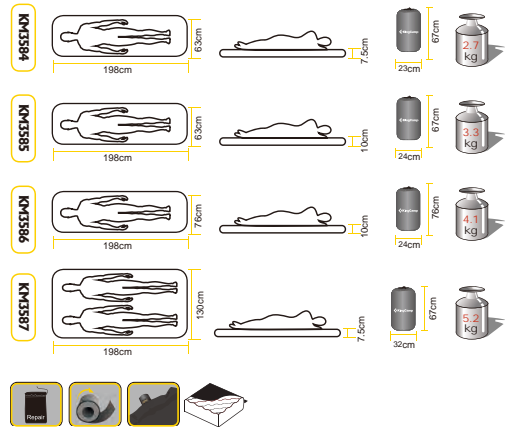

## COMPACT SUPER

### KM3548

产品信息：  
 上部面料：100%聚酯纤维 210T防撕裂格子布贴合TPU  
 底部面料：100%聚酯纤维 75D滴塑春亚纺贴合TPU  
 气嘴：铜气嘴加工程塑料帽保护  
 外袋：100%聚酯纤维 150D牛津布收口袋  
 产品特点：  
 三段式海绵结构，透气排汗，增加舒适度；  
 防撕裂格子布TPU贴合，提升耐磨性和抗撕裂性；  
 底部防滑滴塑设计，提升使用的便利性；  
 铜气嘴设计，使用方便，寿命更长；  
 附赠收纳外袋、弹力捆扎织带以及修补包。

#### Technical Specification:

TOP Fabric:210T Polyester ripstop TPU coating

Bottom Fabric:75D Poly-pouch TPU coating

Valve:Brass with plastic cap

Carry bag:150D Oxford stuff sack

#### Feature:

Middle wave and end egg pattern for added comfort and reduced sleeping bag slide. Heavy duty abrasion resistant non-slip(v shape) base fabric withstands rugged outdoor terrain.

Free-flowing, non-corrosive brass valve make inflation and deflation of the camping pad quick and easy.



## COMPACT DELUXE

### KM3582

产品信息：  
 上部面料：100%聚酯纤维 240T防撕裂格子布贴合TPU  
 底部面料：100%聚酯纤维 240T防撕裂格子布贴合TPU  
 气嘴：铜气嘴加工程塑料帽保护  
 外袋：100%聚酯纤维 150D牛津布收口袋  
 产品特点：  
 上半部分填充蜂窝型表面海绵，提升防滑性，增加舒适性；  
 下半部分菱形竖打孔海绵，减轻重量，方便快速充气放气；  
 硅胶KINGCAMP大LOGO，美观醒目。

#### Technical Specification:

TOP Fabric:240T Poly-pouch ripstop TPU coating

Bottom Fabric:240T Poly-pouch ripstop TPU coating

Valve:Brass with plastic cap

Carry bag:150D Oxford stuff sack

#### Feature:

Rapid Rise open cell foam featuring Hex-Lift pattern for added comfort and reduced sleeping bag slide. Diamond pattern at foot helps reduce overall weight.

Unique Hex-Lite Ripstop fabric.

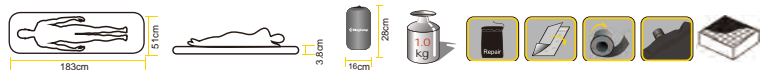



## COMFORT PLUS

### KM3583

**产品信息：**

上部面料：100%聚酯纤维 桃皮绒贴合TPU  
 底部面料：100%聚酯纤维 75D春亚纺贴合TPU  
 气嘴：铜气嘴加工程塑料帽保护  
 外袋：100%聚酯纤维 150D牛津布收口袋

**产品特点：**

三段式海绵填充结构，透气排汗，提升使用便利；  
 扶手以及枕头设计，充分贴合身体，睡眠更为舒适；  
 铜气嘴设计，使用方便，寿命更长；  
 附赠收纳外袋、弹力捆扎织带以及修补包。

**Technical Specification:**

TOP Fabric:100%Polyester 75D Micro Brushed TPU coating

Bottom Fabric:75D Poly-pouch TPU coating

Valve:Brass with plastic cap

Carry bag:150D Oxford stuff sack

**Feature:**

Easy to use, eco-friendly(240T polyester TPU coating), self-inflating sleep pad has a built-in pillow and raised sides for an added layer of comfort. Jet Stream Wave Open Cell Foam for faster inflating and deflating, and add comfort.



## COMFORT DELUXE

### KM3544

**产品信息：**

上部面料：100%聚酯纤维 麂皮绒贴合TPU  
 下部面料：100%聚酯纤维 75D滴塑春亚纺贴合TPU  
 气嘴：铜气嘴加工程塑料帽保护

**产品特点：**

波浪表面海绵结构，增加睡眠舒适度；麂皮绒面料，吸湿保暖；  
 底部防滑滴塑设计，提升使用的便利性；  
 铜气嘴设计，使用方便，寿命更长；  
 附赠收纳外袋、弹力捆扎织带以及修补包。

**Technical Specification:**

Brushed "Suede-like" Top Fabric - extra comfort and less sliding.

Heavy duty abrasion resistant base fabric withstands rugged outdoor terrain and Anti-slip dots on bottom

fabric - slides less on tent floor.



## COMFORT DOUBLE KM3084

### 产品信息：

上部面料：100%聚酯纤维 桃皮绒贴合TPU

底部面料：100%聚酯纤维 桃皮绒贴合TPU

气嘴：铜气嘴加工程塑料帽保护

外袋：100%聚酯纤维 150D牛津布收口袋

### 产品特点：

三段式海绵填充结构，透气排汗，提升使用便利；

附带枕头设计，充分贴合头部，睡眠更为舒适；

双铜气嘴设计，使用方便，寿命更长；

附赠收纳外袋、弹力捆扎织带以及修补包。

### Technical Specification:

TOP Fabric:100%Polyester 75D Micro Brushed TPU coating

Bottom Fabric:100%Polyester 75D Micro Brushed TPU coating

Valve:Brass with plastic cap

Carry bag:150D Oxford stuff sack

### Feature:

Easy to use, eco-friendly, self-inflating sleep pad has a built-in pillow for an added layer of comfort.

Jet Stream Wave Open

Cell Foam for faster inflating and deflating ,and add comfort.

Free-flowing, non-corrosive brass valve make inflation and deflation of the camping pad quick and easy.

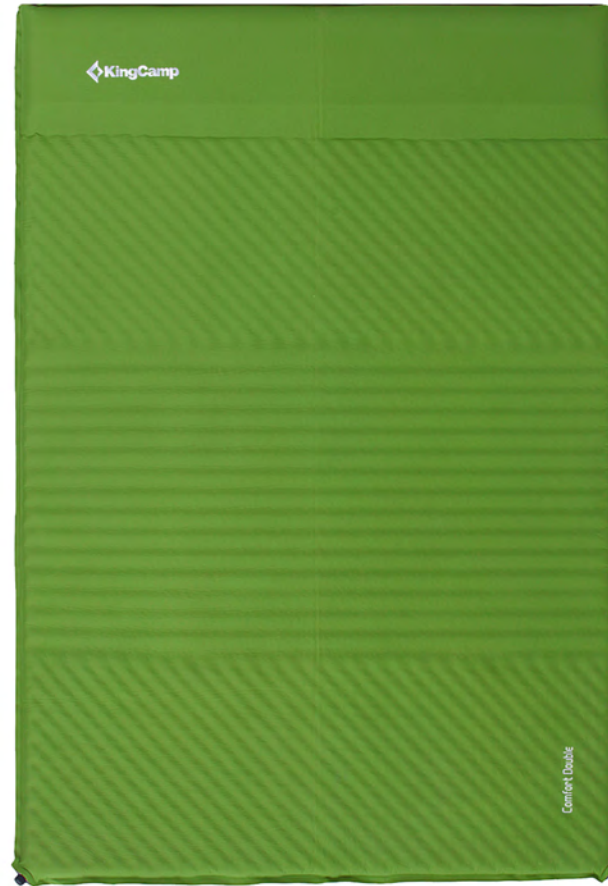
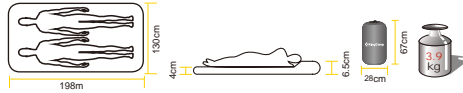



## COMFORT DOUBLE KM3594

产品信息：  
 上部面料：100%聚酯纤维 桃皮绒贴合TPU  
 底部面料：100%聚酯纤维 桃皮绒贴合TPU  
 气嘴：铜气嘴加工程塑料帽保护  
 外袋：100%聚酯纤维 150D牛津布收口袋  
 产品特点：  
 三段式海绵填充结构，透气排汗，提升使用便利；  
 额外赠送自充气枕头，睡眠更为舒适；  
 双铜气嘴设计，使用方便，寿命更长；  
 附赠收纳外袋、弹力捆扎织带以及修补包。

Technical Specification:  
 TOP Fabric: 100%Polyester 75D Micro Brushed PVC coating  
 Bottom Fabric: 100%Polyester 75D Micro Brushed PVC coating  
 Valve: Brass with plastic cap  
 Carry bag: 150D Oxford stuff sack  
 Features:  
 Additional two pillows;  
 Two Free-flowing, non-corrosive brass valves ;  
 Triple zone comfort pattern; Multi-purpose;  
 Easy to storage and carry.

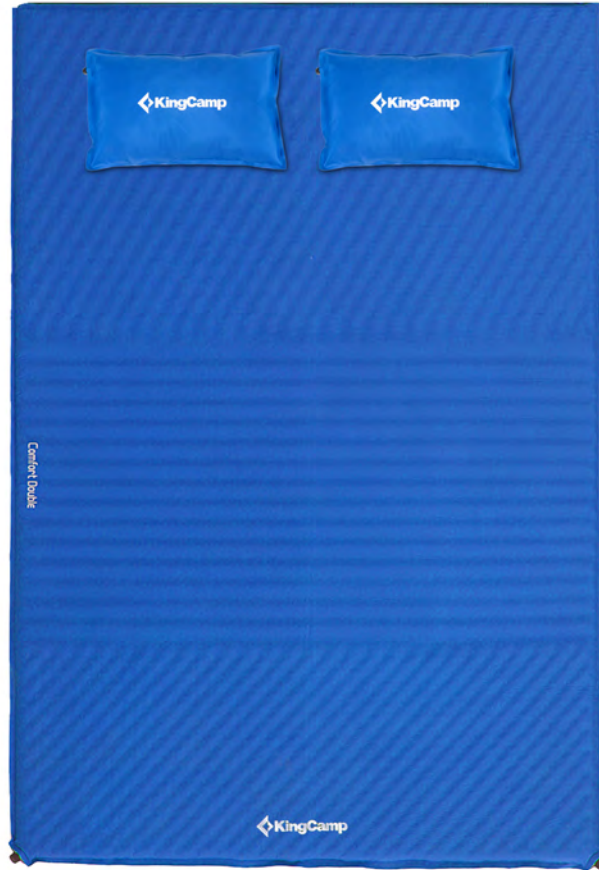
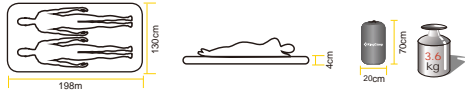



## BASE CAMP L KM3505

**产品信息：**  
 上部面料：100%聚酯纤维 190T涤纶贴合PVC  
 底部面料：100%聚酯纤维 190T涤纶贴合PVC  
 气嘴：工程塑料气嘴  
 外袋：100%聚酯纤维 牛津布收口袋  
**产品特点：**  
 自带充气枕头，贴合头部，提升户外睡眠舒适度；  
 两侧子母扣设计，可自由无限拼接，增强使用便利性；  
 点式表面工艺，提升牢固度，延长使用寿命；  
 卡扣式织带卷包方式，方便收纳存放。

**Technical Specification:**  
 TOP Fabric: 190T Polyester PVC coating  
 Bottom Fabric: 190T Polyester PVC coating  
 Valve: ABS  
 Carry bag: 150D Oxford stuff sack  
**Features:**  
 Attaches and Detaches Securely Snap button and  
 Very easy to add more pads to extend the width freely.  
 Attached Pillow structure for compact nighttime  
 comfort and support. Spot-bonded Technology,  
 more comfortable and Durable.



## BASE CAMP XL KM3559 BASE CAMP COMFORT KM3560

**产品信息：**  
 上部面料：100%聚酯纤维 190T涤纶贴合PVC  
 底部面料：100%聚酯纤维 190T涤纶贴合PVC  
 气嘴：工程塑料气嘴  
 外袋：100%聚酯纤维 牛津布收口袋  
**产品特点：**  
 自带充气枕头，贴合头部，提升户外睡眠舒适度；  
 两侧子母扣设计，可自由无限拼接，增强使用便利性；  
 点式表面工艺，提升牢固度，延长使用寿命；  
 卡扣式织带卷包方式，方便收纳存放。

**Technical Specification:**  
 TOP Fabric: 190T Polyester PVC coating  
 Bottom Fabric: 190T Polyester PVC coating  
 Valve: ABS  
 Carry bag: 150D Oxford stuff sack  
**Features:**  
 Attaches and Detaches Securely Snap button and  
 Very easy to add more pads to extend the width freely.  
 Attached Pillow structure for compact nighttime  
 comfort and support. Spot-bonded Technology,  
 more comfortable and Durable.



## ULTRALIGHT PUMP AIRBED

### KM3507

产品信息：  
 上部面料：100%聚酯纤维 190T涤纶贴合PVC  
 底部面料：100%聚酯纤维 190T涤纶贴合PVC  
 气嘴：PVC+内置海绵气泵  
 外袋：100%聚酯纤维 牛津布收口袋  
 产品特点：  
 内置海绵气泵，方便快速充气；  
 附带连接式一体枕头结构，舒适夜晚睡眠；  
 波浪式表面，提升舒适度和耐用度。

Technical Specification:  
 TOP Fabric:190T Polyester PVC coating  
 Bottom Fabric:190T Polyester PVC coating  
 Valve: PVC + Built in foam pump  
 Carry bag:150D Oxford stuff sack  
 Features:  
 Attached Pillow structure for compact nighttime comfort and support. Internal pump for easy and fast inflation.  
 Wave beam construction for comfort and durability.

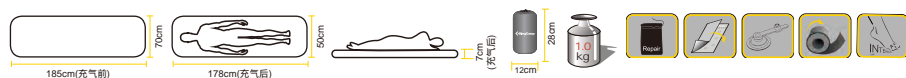

## PUMP AIRBED SINGLE KM3588 PUMP AIRBED DOUBLE KM3589

产品信息：  
 上部面料：100%聚酯纤维 190T涤纶贴合PVC  
 底部面料：100%聚酯纤维 190T涤纶贴合PVC  
 气嘴：PVC+内置海绵气泵  
 外袋：100%聚酯纤维 150D牛津布收口袋  
 产品特点：  
 内置海绵充气泵，方便快捷充气；PVC贴合材料高承重；  
 波式表面，舒适耐用；附赠收纳外袋以及修补包

Technical Specification:  
 TOP Fabric:100%Polyester 190T PVC coating  
 Bottom Fabric:100%Polyester 190T PVC coating  
 Valve:PVC + Built in foam pump  
 Carry bag:150D Oxford stuff sack  
 Features:  
 Internal pump for easy and fast inflation;  
 PVC laminated with 190T Polyester Fabric;  
 Wave beam construction;  
 included an oversized carrying bag and Repair Kit.

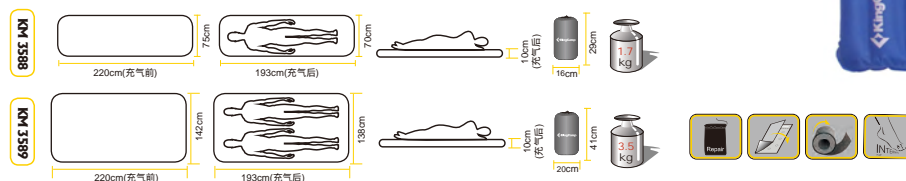
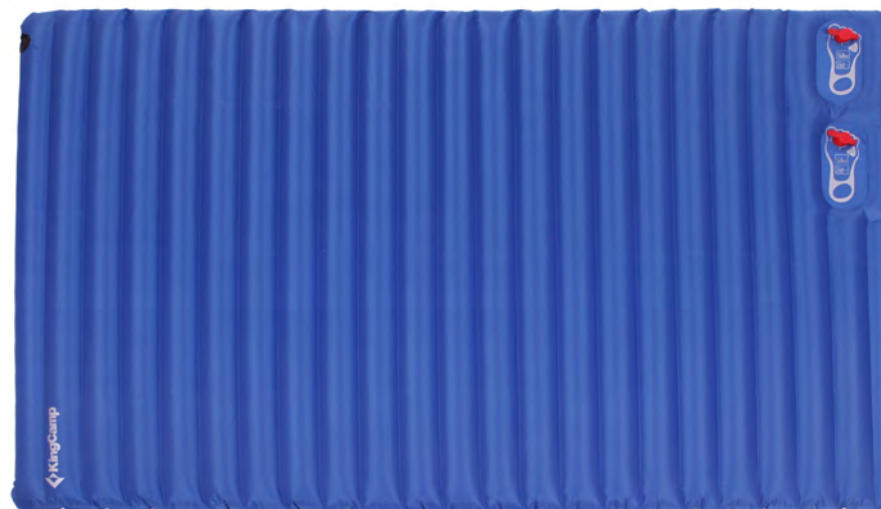

## KING AIEBED DOUBLE

### KM3590

**产品信息：**

上部面料：100%聚酯纤维 150D牛津布贴合TPU

底部面料：100%聚酯纤维 150D牛津布贴合TPU

气嘴：波士顿安全螺旋气嘴

外袋：100%聚酯纤维 150D牛津布收口袋

**产品特点：**

牛津布贴合TPU，更轻便，使用寿命更强，更环保；

上下面之间设置192根稳定拉条，更舒适；

波士顿气嘴，便于充气放气，方便调节气床舒适度；

附赠电池气泵、收纳外袋、弹力捆扎带以及修补包。

**Technical Specification:**

TOP Fabric:100%Polyester 150D Oxford TPU coating

Bottom Fabric:100%Polyester 150D Oxford TPU coating

Valve:Boston valve

Carry bag:150D Oxford stuff sack

**Features:**

Oxford laminated TPU(Thermo Plastic Polyurethane) material ;

Adjust firmness and comfort freely thanks to the two-way

Boston valve and 192 stabilizers;

included battery operated pump,compression straps,

an oversized Oxford carrying bag and Repair Kit.



## FLOCKED AIRBED SINGLE KM3519A

## FLOCKED AIRBED DOUBLE KM3531

**产品信息：**

上部面料：植绒PVC

底部面料：PVC

气嘴：波士顿安全螺旋气嘴

外袋：100%聚酯纤维 210D牛津布收口袋

**产品特点：**

植绒PVC面料，柔软结实耐用，气密性好；

波浪式表面，充分支撑身体，睡眠舒适；

附赠牛津布拉链外袋，方便收纳整理。

**Technical Specification:**

TOP Fabric: Flocked top PVC

Bottom Fabric:PVC

Valve: Boston valve

Carry bag: 210D Oxford zipper handbag

Features: Flocked surface is soft, comfortable,

and prevents bedding from sliding off.

Wave beam construction for a uniform sleeping surface.

Crafted with cozy flocked tops and heavy gauge vinyl that

is durable and easy to maintain.Location, temperature,

and humidity will affect the firmness of the airbed.

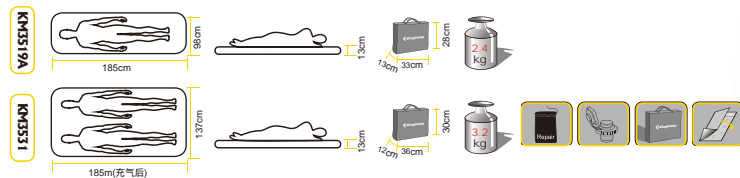



## BACKSEAT AIRBED

### KM3532

产品信息：  
 上部面料：植绒PVC  
 底部面料：PVC  
 气囊：PVC  
 外袋：100%聚酯纤维 210D牛津布收口袋  
 产品特点：可与多款车型搭配，提供车内休息平躺空间，解除旅途之困；植绒PVC面料，柔软结实耐用，气密性好；波浪式表面，充分支撑身体，睡眠舒适；附赠牛津布拉链外袋，方便收纳整理。

Technical Specification:  
 TOP Fabric: Flocked top PVC  
 Bottom Fabric: PVC  
 Valve: PVC  
 Carry bag: 210D Oxford zipper handbag  
 Features: Mix with a variety of models, to form the space lying in the back seat, lifting the journey lack of storm.  
 Flocked surface is soft, comfortable, and prevents bedding from sliding off. Wave beam construction for a uniform sleeping surface.  
 Crafted with cozy flocked tops and heavy gauge vinyl that is durable and easy to maintain. Location, temperature, and humidity will affect the firmness of the airbed.

充气后尺寸：

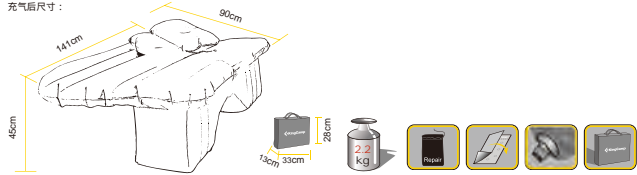

## SLEEPING PAD KM3603 SLEEPING PAD L KM3604

产品信息：  
 上部面料：100%棉  
 底部面料：100%聚酯纤维 磨毛滴塑处理  
 填充：100%聚酯纤维 250g/m<sup>2</sup>  
 外袋：100%聚酯纤维 210D牛津布  
 产品特点：  
 配合行军床使用，全棉面料，舒适温暖；  
 底部磨毛春亚纺滴塑，耐磨防滑，  
 更好睡眠体验；轻便易携带。

Technical Specification:  
 TOP Fabric: 100% Cotton  
 Bottom Fabric: 100% Polyester  
 Filling: 100% Polyester 250g/m<sup>2</sup>  
 Carry bag: 210D Oxford stuff sack  
 Features:  
 Cot size;  
 Elastic bands design;  
 Light and portable;  
 Comfort and durable.



NEW









## KingCamp背包功能科技 KingCamp Backpack Technical Information



### K.A.C.空气调节器

背部选用超强透气性点状分离支撑系统，当背负时可使背部和背包分离，确保了优越的透气性。在潮湿和炎热的气候环境下，保证背部的干爽。为了提高背负时的稳定性，背部嵌入聚乙烯树脂支撑板。

Ventilation is provided by a duct situated between the back of the rucksack and the back of the net. By restricting the area of contact to 6 points, this creates a current of air and perspiration is equally reduced. The frame transfers the weight to the waist belt and the load stays close to the back of the net.



### V.U.S.空气调节系统

拥有优越的透气性，保证背部的干爽，根据人体在背包负重的情况下背部受力特点精心打造背部线条，嵌入聚乙烯树脂支撑板，超轻铝管弧形支撑系统。确保了背负的稳定性，提供了优越的舒适性。

The V.U.S. back guarantees great breathability and dryness. Combining an aluminum tube with a poly ethylene panel ensures excellent carrying stability, and the shaped padding offers better weight distribution.



### A.C.S.背负系统

A.C.S.背负系统是KINGCAMP公司根据人体力学原理研发的一款舒适，高透气背负系统。确保背包运动中优越的舒适性和背部的干爽。在潮湿和炎热的气候环境下，保证背部的干爽。

Designed by Kingcamp, the A.C.S back system guarantees great breathability and comfort for people of all sizes engaging in a variety of sports in extreme temperatures.



### K.A.S. 可调节背负系统

K.A.S. 可调节器系统是在K.R.S. 系统上做了相应的提升，更加符合人体背部受力特点，确保了负重运动中优越的稳定性，并很好的将重量垂直、均匀、合理分布在胯部。

The K.A.S adjustment panel is an improved version of the K.R.S adjustment back system. By transferring the load to the pelvis (the top of the hip bone), it ensures the highest stability for the backpack.

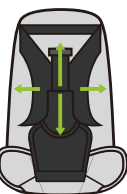

### K.R.S. 调节器系统

K.R.S. 调节器系统是根据人体背部受力特点，经过不断的测试、革新，研发而出的性能卓越的背负系统，背部嵌入聚乙烯树脂支撑板，中部嵌入航空铝条，确保了负重运动中优越的稳定性，并很好的将重量垂直、均匀、合理分布在胯部。肩带及腰带填充双倍高密度海绵，大大提高了背包的舒适性；魔术贴抽带调节设计，依据使用者不同的背部尺寸，调整魔术贴粘带同时移动背部肩带即可轻松调节背负长短，腰带调节轻松自如，并可拆卸使用。

The K.R.S adjustment panel is an innovative adjustable back panel system. The back panel insert has a central self-modeling aluminum framework with a poly ethylene panel ensuring the highest stability. By transferring the load to the top of the hip bone, the strongest part of the skeleton, the load bearing belt reduces the weight on the shoulders, providing increased comfort. The shoulder straps can be altered up or down by opening or closing the self fastening tab on the central part of the harness.



Nifco插扣



多耐福插扣  
Dur-flex Buckle



KingCamp拉链更顺畅、更持久  
KINGCAMP Zipper



KingCamp扣具更持久、耐断裂  
KINGCAMP Buckle



透气回力胶膊带，即防滑又透气  
Breathable elastic rubber belly strap



背包设有悬挂，配件的外挂系统  
Hanger system for outdoor equipment



背包设有音乐播放器的口袋  
Inner music player pocket



背包设有防雨罩保护  
Raincover protection



背包设有饮水口，配上饮水袋  
可以方便随时补充水分  
Hydro system for water bag



背包设有腰部调节带  
增加背包稳定性  
Adjustable waist strap



背包内设安全存放  
笔记本电脑储藏层  
Inner computer player pocket



袋盖可拆卸做为双肩背包使用  
Can take the top cover apart backpack  
Use as a light backpack.



旅行系列背包  
Traveling series



徒步系列背包  
Trekking series



城市休闲系列背包  
City series



背包设有斜挎肩带设计  
Shoulder belt



背包设有安全灯悬挂系统  
Hanger system for safelight



方便快捷储物袋设计  
Rapid pockets



胸部调节带，增加背包稳定性  
Adjustable waist strap



背包两侧网袋设计，方便快捷储物  
Side mesh pocket





## GLACIER 12

**KB3333**

详细说明：

面料：100% 聚酯纤维，PU涂层，防水防泼水

里料：100% 聚酯纤维

容积：12L

尺寸：24x12x40cm

特点：

1. 优质材料，轻薄涤纶，光滑拉链，超细纤维手感好；
2. 简单和整洁的设计与完美的大小，可以把它带到学校，学院，购物，骑自行车，旅行等；
3. 软垫肩带：软垫和可调肩带增加舒适感；独特的设计肩带可以缓解肩上的压力。

Technical Specification:

Material:100% Polyester,PU coating,W/R,W/P

Lining:100% Polyester

Volume:12L

Size: 24x12x40cm

Features:

1. High quality material. Lightweight polyester, smooth zipper, microfiber leather feel good.
2. Simple and tidy design with perfect size that you can take it to school, college, shopping, cycling, traveling etc.
3. Padded straps: Padded and adjustable shoulder straps for added comfortable and ventilated. Unique design straps ease the pressure on the shoulder.



## BISCAYNE 15

**KB3334**

详细说明：

面料：100% 聚酯纤维，PU涂层，防水防泼水

里料：100% 聚酯纤维

容积：15L

尺寸：32×10×18 cm

特点：

1. 优质材料，轻薄涤纶，光滑拉链，超细纤维手感好；
2. 简单和整洁的设计与完美的大小，可以把它带到学校，学院，购物，骑自行车，旅行等；
3. 软垫肩带：软垫和可调肩带增加舒适感。独特的设计肩带可以缓解肩上的压力。

Technical Specification:

Material:100% Polyester,PU coating,W/R,W/P.

Lining:100% Polyester

Volume:15L

Size:32×10×18 cm

Features:

1. High quality material. Lightweight polyester, smooth zipper, microfiber leather feel good.
2. Simple and tidy design with perfect size that you can take it to school, college, shopping, cycling, traveling etc.
3. Padded straps: Padded and adjustable shoulder straps for added comfortable and ventilated. Unique design straps ease the pressure on the shoulder.





## ARCHES 25

### KB3336

详细说明：

面料：100% 聚酯纤维，PU涂层，防水防泼水

里料：100% 聚酯纤维

容积：25L

尺寸：35×15×48 cm

特点：

1. 优质材料，轻薄涤纶，光滑拉链，超细纤维手感好；
2. 简单和整洁的设计与完美的大小，可以把它带到学校，学院，购物，骑自行车，旅行等；
3. 软垫肩带：软垫和可调肩带增加舒适感。独特的设计肩带可以缓解肩上的压力。

Technical Specification:

Material:100% Polyester,PU coating,W/R,W/P.

Lining:100% Polyester

Volume:25L

Size:35×15×48 cm

Features:

1. High quality material. Lightweight polyester, smooth zipper, microfiber leather feel good.
2. Simple and tidy design with perfect size that you can take it to school, college, shopping, cycling, traveling etc.
3. Padded straps: Padded and adjustable shoulder straps for added comfortable and ventilated. Unique design straps ease the pressure on the shoulder.



## MINNOW 15

### KB4231

详细说明：

面料：100% 聚酯纤维，PU涂层，防水防泼水

里料：100% 聚酯纤维

容积：15L

尺寸：28×12×37 cm

特点：

1. 优质材料，轻薄涤纶，光滑拉链，超细纤维手感好；
2. 简单和整洁的设计与完美的大小，可以把它带到学校，学院，购物，骑自行车，旅行等；
3. 软垫肩带：软垫和可调肩带增加舒适感。独特的设计肩带可以缓解肩上的压力。

Technical Specification:

Material:100% Polyester,PU coating,W/R,W/P.

Lining:100% Polyester

Volume:15L

Size:28×12×37 cm

Features:

1. High quality material. Lightweight polyester, smooth zipper, microfiber leather feel good.
2. Simple and tidy design with perfect size that you can take it to school, college, shopping, cycling, traveling etc.
3. Padded straps: Padded and adjustable shoulder straps for added comfortable and ventilated. Unique design straps ease the pressure on the shoulder.





## ACADIA 15

### KB3321

详细说明：

面料：100%聚酯纤维，双色舞龙布，PU涂层，防水防泼水

里料：100%聚酯纤维，T/C里布

容积：15L

尺寸：28x35x11cm

背负系统：海绵人字形缝合

附件：可调节侧袋，包内合理分仓

特点：休闲风格，可双肩背、可手提；

人性化的侧袋设计，不用时用魔术贴粘合，

处于收紧状态，干净利落；

使用时可快速展开，

魔术贴的勾面粘到相邻的毛面上，有效防止勾衣服。

Technical Specification:

Material:100% Polyester, PU coating, W/R, W/P.

Lining: 100% Polyester

Volume:15L

Size: 28x35x11cm

Support Style: Foam stitching back

Access: Adjustable side pockets.

Feature: Casual style, backpack and hand bag, adjustable side pockets. Inner sleeve for ipad.



## REDWOOD 25

### KB3322

详细说明：

面料：100%聚酯纤维，双色舞龙布，PU涂层，防水防泼水

里料：100%聚酯纤维，T/C里布

容积：25L

尺寸：30x42x13cm

背负系统：海绵+三明治网布

特点：

1、两个电脑仓，增加了一个后背隐藏式电脑隔仓，携带电脑更安全

2、抽绳收口式主仓，扩展了主仓容量，取放物品更方便

3、带袋盖的侧袋，容量大，可放500ml的水瓶

Technical Specification:

Material:100% Polyester, PU coating, W/R, W/P.

Lining: 100% Polyester

Volume:25L

Size: 30x42x13cm

Support Style: Foam stitching and sandwich mesh back

Feature:

1.Casual style, two sleeves for laptops.

2.Drawingstring shut style main compartment

3. Side pockets with flap, large capacity, can put in 500ml bottle.







## YELLOWSTONE 15

### KB3323

详细说明：  
 面料：100%聚酯纤维，双色舞龙布，PU涂层，防水防泼水  
 里料：100%聚酯纤维，T/C里布  
 容积：15L  
 尺寸：28x35x11cm  
 背负系统：海绵人字形纤维  
 附件：抽绳收口式主仓，扩展了容量，取放物品更方便  
 特点：户外面料与时尚款式相结合，防水的同时更加时尚

Technical Specification:  
 Material:100% Polyester, PU coating, W/R, W/P.  
 Lining: 100% Polyester  
 Volume:15L  
 Size: 28x35x11cm  
 Support Style: Foam stitching back  
 Access: Drawstring shut style main compartment  
 Feature: Casual style with waterproof fabric, fashion style.



## ZION 15

### KB3327

详细说明：  
 面料：100%聚酯纤维，双色舞龙布，PU涂层，防水防泼水  
 里料：T/C里布  
 容积：15L  
 尺寸：33x45x11cm  
 背负系统：海绵纤维  
 附件：肩带  
 特点：  
 双肩背、斜挎、手提三种用法，  
 2个电脑仓，1个Ipad仓，满足商务人士的需求

Technical Specification:  
 Material:100% Polyester, PU coating, W/R, W/P.  
 Lining: T/C lining  
 Volume:15L  
 Size: 33x45x11cm  
 Support Style: Foam stitching back  
 Access: shoulder strap  
 Feature:  
 three using method, backpack, shoulder bag, hand bag.  
 Two sleeves for laptops, one sleeve for ipad. Idea for business.





**MINNOW**  
**KB4229**

详细说明：  
面料：100%聚酯纤维 一分格/PU；  
防水800mm，防泼水  
里料：100% 聚酯纤维  
尺寸：28x12x37cm  
容积：12升  
特点：  
重量轻，时尚，小巧，  
适合城市休闲使用。

Technical Specification:  
Material:300D Ripstop PU coating W/R W/P  
Liner:Polyester  
Size:28x12x37cm  
Volume:12L  
Feature:  
Light weight, Idea for City.



**EMMA 翼马**  
**KB3311**

产品信息：  
面料：100%锦纶，方形格防撕裂，防泼水  
尺寸：20x15x6cm  
附件：YKK拉链，YNS扣具，高品质保障  
特点：超轻、可收纳、小巧、携带方便。

Technical Specification:  
Material:100% polyamide  
Size: 20x15x6cm  
Feature:  
light weight, can pack in a small bag, easy carry.



**EMMA 翼马**  
**KB3309**

产品信息：  
面料：100%锦纶，方形格防撕裂，防泼水  
容积：12L  
附件：YKK拉链，YNS扣具，高品质保障。

Technical Specification:  
Material:100%polyamide  
Size: 12L  
Feature: light weight, can pack in a coins bag.

P-83



KB3333  
Size: 24x12x40cm  
Volume: 12L

P-83



KB3334  
Size: 32x10x18cm  
Volume: 15L

P-84



KB3336  
Size: 35x15x48cm  
Volume: 25L

P-84



KB4231  
Size: 28x12x37cm  
Volume: 15L

P-85



KB3321  
Size: 28x35x11cm  
Volume: 15L

P-85



KB3322  
Size: 30x42x13cm  
Volume: 25L

P-86



KB3323  
Size: 28x35x11cm  
Volume: 15L

P-86



KB3327  
Size: 33x45x11cm  
Volume: 15L

P-87



KB4229  
Size: 28x12x37cm  
Volume: 12L

P-87



KB3309  
Volume: 12L

P-87



KB3311  
Size: 20x15x6cm



背包系列  
BACKPACK RANGE



## KingCamp家具功能科技 KingCamp Furniture Technical Information



牛津布外袋 可背、可提  
Oxford carry bag could bear on the shoulder or in hand



桌腿折叠后桌面向下收纳  
The desktop fold downward after the legs folded



左右收纳  
Folding to the middle from left and right



前后收纳  
Folding to the middle from front and back



四面折叠收纳  
Folding to the middle from four directions



防紫外线  
Anti-UV



防泼水  
Water Proof



适用人数  
Apply to



最大承重  
Loading Weight



重量  
Weight



### KingCamp家具

户外家具是KingCamp装备类产品中最具竞争实力的一大类产品，经过多年不断的开发及改进，KingCamp户外家具及野餐系类产品成为国内自驾车装备中的第一品牌，产品涵盖折叠椅系列，折叠桌系列及折叠床等几大类，是自驾车出游，家庭露营及休闲活动必选产品，2012年公司根据产品的特点，及销售渠道的不同，将产品细分为：奢华，豪华，舒适，轻便，优价，儿童，可选等七大系类，使每一个家庭户外的爱好者，根据自己的需要，找到并享受真正属于自己的幸福！

### Outdoor Furniture

Outdoor furniture is essential for a comfortable and relaxing camping trip. There is simply nothing you deserve more than a comfy chair and a cool beverage once you've put up your tent. After acquiring a tent for your camping holiday, you can begin to broaden your collection of outdoor equipment and furniture. KingCamp has a varied range of furniture items on offer for outdoor and camping activities.

## BAMBOO COOKING TABLE

### 竹面快速打开烧烤桌

#### KC3904

产品信息：

尺寸：75X49X82cm

面料：600X300D牛津布，

颜色：黑色/橙色

支架：铝管，阳极氧化

层板：中密度纤维板

顶板：竹板，厚度1.0CM

特点：

快速打开、折叠，免搭建。纯天然竹面。

门帘可收起卷在门上方，背部加高密纱网，防止蚊虫进入，亦可通风有利于食物保鲜；

中间层板可抽出。

挡风板用吸扣固定，方便移动调整和拿取。

Technical Specification:

Size:75X49X82cm

Fabric:600X300D oxford

Color:black/orange

Frame:Aluminum,Grey color anodized

Material:Nature bamboo table top

Features:

Open and fold in seconds;

Big storage;Safe for using;

Mesh back panel for ventilation;

Light weight;

Easy for transportation & storage.



荣获2013亚洲户外产业大奖（银奖）



## FOLDING BAMBOO GRILLING TABLE L

### 大号竹面折叠烧烤桌

#### KC3914

产品信息：

尺寸：100x49x82cm

面料：600x300D牛津布

支架：铝管

颜色：黑色

层板：中密度纤维板

顶板：竹板，厚度1cm

产品特点：

免搭建。纯天然竹板。

门帘可完全卷起，背部加高密纱网，防止蚊虫进入，亦可通风有利于实物保鲜。

灯杆可以悬挂营地灯，方便夜晚使用。

侧面铝框和挂钩方便悬挂杂物袋。

Technical Specification

Size:100x49x82cm

Fabric:600x300D Oxford

Frame:Aluminum

Color:Black

Material:Bamboo for table top, MDF for operation desk

Features:

Open and fold in seconds;

Big storage;

Bamboo table safe for using;

Mesh back panel for ventilation;

Light weight;

Easy for transportation & storage.



## MULTIFUNCTIONAL COOKING TABLE

### 多功能组合烧烤台

#### KC3941

产品信息：

尺寸：189x46x86cm  
 面料：600X300D牛津布，  
 颜色：黑色/橙色  
 支架：铝管阳极氧化处理  
 顶板：不锈钢  
 层板：中密度纤维板  
 挡风板：铁  
 水盆：PVC

特点：多功能：集储物柜、烧烤台、操作台、  
 洗涤洗手盆、扩展台（可作控水台或放垃圾袋）于一体。  
 折叠性强：储物柜、所有支架均可折叠。  
 携带方便：配有拖轮和把手，可以行李箱一样拉走。

Technical Specification

Size: 189x46x86cm

Frame: Aluminum,

Material: Stainless for table top,

MDF for Operation desk, PVC for Basin

Color: Black

Features: Open and fold in seconds;

Stainless table top, durable and easy to clean;

Multifunctional; With wheel & handle,

Easy for carrying & storage.



## MULTIFUNCTIONAL BAMBOO COOKING TABLE

### 多功能竹面组合烧烤台

#### KC3942

产品信息：

尺寸：190x46x86cm

颜色：黑色

面料：600x300D牛津布

支架：阳极氧化处理铝管

顶板：竹板

切菜板：竹板

层板：中密度纤维板

特点：集储物柜、切菜板、烧烤台、水盆于一体；

两个竹面板；有泄水阀；

折叠体积小。

Technical Specification

Size: 190x46x86cm

Color: Black

Fabric: 600x300D Oxford

Frame: Aluminum

Top Table: Bamboo

Cutting Board: Bamboo

Layer Board: MDF

Features:

Set storage cabinets, cutting board, barbecue table, basin in one;

Double bamboo board; Discharge valve;

Small folding size.

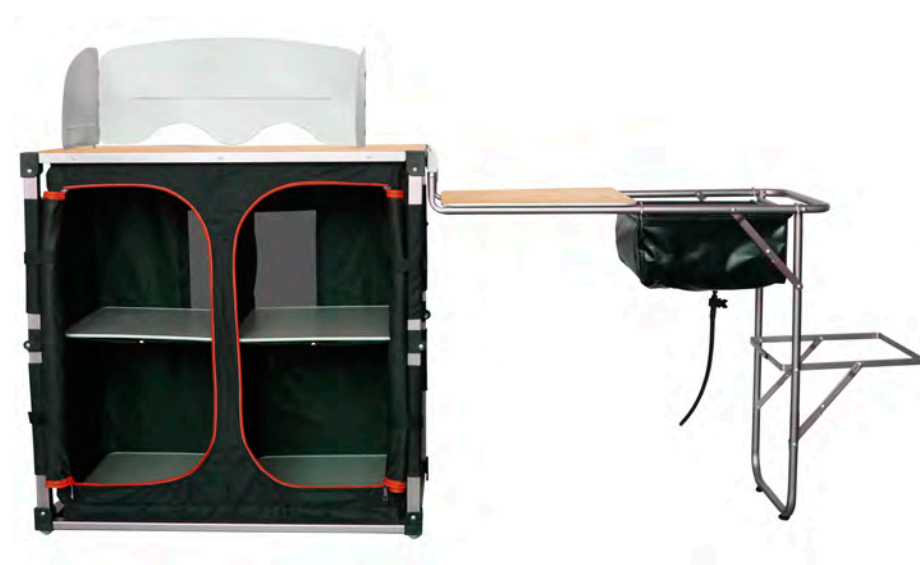



## ULTRA-LIGHT STORAGE CABINETS

### 超轻储物柜

**KC3943**

产品信息：  
尺寸：60x46x85cm  
颜色：灰色，红色  
面料：600x300D牛津布  
支架：阳极氧化处理铝管  
顶板：折叠竹板  
特点：  
重量轻；折叠体积小；  
竹面板；灯杆；带挂钩侧架。

Technical Specification:  
Size:60x46x85cm  
Color:Grey,red  
Fabric:600x300D Oxford  
Frame:Aluminum  
Top Table:Folding Bamboo  
Features:  
Ultra-light; Small folding size;  
Bamboo board; Light pole; Hooks.



## STOVE SHELF

### 烤炉架

**KC3944**

产品信息：  
尺寸：60x45x63cm  
颜色：银色  
支架：铝合金  
特点：  
用于放置烤炉；  
宽度可以调节，适用于不同大小的烤炉；  
拆装简便；收纳体积小；重量轻。

Technical Specification:  
Size:60x45x63cm  
Color:Silver  
Frame:Aluminum  
Features:  
Using with a stove;  
adjustable width for a large range of size;  
easy to assemble and disassemble;  
folded size is small; light weight.



## BARBECUE TABLE

### 烧烤桌

**KC3931**

产品信息：  
尺寸：72x50x31/41cm  
桌面：竹板  
支架：铝  
特点：  
中间竹板可拆，放置烤炉；  
高度可调节；  
快速打开和折叠。

Technical Specification:  
Size:72x50x31/41cm  
Top Table:Bamboo  
Frame:aluminum  
Features:  
The middle bamboo plate is removable;  
Adjustable Height;  
Open and fold in seconds.



4-FOLDING BAMBOO TABLE L 大号四折竹面桌 **KC3953**  
 4-FOLDING BAMBOO TABLE M 中号四折竹面桌 **KC3954**  
 4-FOLDING BAMBOO TABLE S 小号四折竹面桌 **KC3955**



产品信息:  
 尺寸: 100x65x42/65cm ( KC3953 )  
 80x60x42/65cm ( KC3954 )  
 65x50x42/65cm ( KC3955 )  
 支架: 铝合金  
 桌面: 竹板  
 特点: 快速打开和折叠;  
 纯天然竹面, UV处理, 日晒后不会变形;  
 打开后使用空间大, 高度可调节;  
 承重力强, 支架稳定, 打开不易摇晃  
 收纳体积减小3/4, 轻便, 方便携带。

Technical Specification:  
 Size:100x65x42/65cm(KC3953)  
 80x60x42/65cm(KC3954)  
 65x50x42/65cm(KC3955)  
 Frame:Aluminum  
 Material:Natural bamboo table top  
 Features:  
 Open and fold in seconds; Pure bamboo;  
 Table top folded in quarter;  
 Lightweight;  
 Easy carrying.



(KC3953)



(KC3954)



(KC3955)

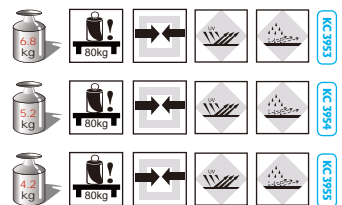

BAMBOO FOLDING TABLE  
 竹面小方桌  
**KC3981**

产品信息:  
 尺寸: 60x60x40/58cm  
 支架: 铝合金  
 桌面: 竹板  
 特点: 易于组装;  
 纯竹桌面;全铝支架  
 轻巧;携带方便

Technical Specification:  
 Size:60x60x40/58cm  
 Frame: Aluminum  
 Material: Natural Bamboo Table top  
 Features:  
 Easy to assemble; Pure Bamboo;  
 Light weight; Easy to carry



BAMBOO FOLDING TABLE  
 竹面小圆桌  
**KC3892**

产品信息:  
 尺寸: 60x60x39cm  
 支架: 铝合金  
 桌面: 竹板  
 特点: 1秒展开和收纳  
 易组装, 纯竹桌面  
 轻便, 易携带

Technical Specification:  
 Size: 60x60x39  
 Frame: Aluminum  
 Material: Natural Bamboo Table top  
 Features:  
 Open and folds in seconds  
 Easy to assemble; Pure Bamboo;  
 Light weight; Easy to carry



## BAMBOO FOLDING TABLE

### 竹面折叠桌

#### KC3928

产品信息：

尺寸：100x72x50/60/70cm

支架：铝合金,阳极氧化处理

桌面：竹板

颜色：黄色

特点：纯天然竹面，清新袭人，竹板经炭化、UV处理，日晒不会变形；折叠后为手提箱样式，携带方便，打开后使用空间大；支架稳定，打开后不摇晃。竹板承重能力强。高度可调节。

Technical Specification:

Size:100x72x50/60/70cm

Frame:Aluminum,

Material:Nature bamboo table top

Color:Yellow

Features:Open and fold in seconds;

Pure Bamboo, Anti-UV, Water-proof, Heavy duty,

Environmental, Easy for carrying & storage.



## BAMBOO FOLDING TABLE

### 竹面折叠桌

#### KC3929

产品信息：

尺寸：120X70X48/57/70cm

支架：铝合金

桌面：竹板

特点：

纯天然竹面，美观大方，竹板UV处理，日晒不会变形，支架稳定，打开不易摇晃，承重力强，高度可调节。

Technical Specification:

Size: 120X70X48/57/70cm

Frame: Aluminum

Material: Natural Bamboo Table top

Features:

Open and folds in seconds;

Pure bamboo; Table top folded in half;

Light weight; Easy carrying.





## ELLIPTIC BAMBOO TABLE

### 椭圆竹面桌

**KC3926**

产品信息：  
尺寸：120x80x46/68cm  
支架：铝合金  
桌面：竹板+铝制包边

特点：  
椭圆型设计优雅时尚，美观大方，实用型也强；  
桌面由户外折叠桌常用的MDF板换成竹板，  
自重没有增加，承重大大增强；  
竹板经炭化防UV处理日晒不变形。  
竹面平整顺滑防泼水，方便使用后的擦洗；  
高度可调节，适合多场合使用；  
折叠后为手提箱样式，方便携带。

Technical Specification:  
Size: 120x80x46/68cm  
Frame: Aluminum  
Material: Nature bamboo table top  
Features: Easy to assembly; Big size;  
Two adjustable heights  
Pure Bamboo, Anti-UV, Water-proof,  
Heavy duty, Environmental,  
Easy for carrying & storage.



## BAMBOO TABLE S 小号竹面桌 KC3935

## BAMBOO TABLE L 大号竹面桌 KC3936

产品信息：  
45x60x27/59cm ( KC3935 )  
60x90x38/68cm ( KC3936 )  
支架：高强度铝合金支架  
材料：纯天然竹子桌面  
特点：安装方便，纯天然竹面，  
两个高度可选择，轻便，易携带。

Technical Specification:  
Size: 45x60x27/59cm(KC3935)  
60x90x38/68cm(KC3936)  
Frame: Aluminum  
Material: Natural bamboo table top  
Features: Open and folds  
in seconds, Two heights,  
Pure Bamboo, Anti-UV,  
Water-proof, Heavy duty,  
Environmental, Light weight,  
Easy for carrying & storage.



**6-SIDE FOLDING BAMBOO TABLE M 中号竹面六边桌 KC3956**  
**6-SIDE FOLDING BAMBOO TABLE L 大号竹面六边桌 KC3957**

产品信息：  
 尺寸：φ100x50/70cm (KC3956)  
 φ120x47/57/67cm (KC3957)  
 桌面：竹面  
 支架：铝管  
 产品特点：  
 纯天然竹面，清新宜人，竹板经碳化、UV处理，日晒不变形；  
 使用面积大；铝管支架，使用稳定，不摇晃。  
 高度可调节，承重能力强。

Technical Specification:  
 Size:φ100x50/70cm(KC3956)  
 φ120x47/57/67cm(KC3957)  
 Material:Nature bamboo table top  
 Frame:Aluminum  
 Features:  
 Open and fold in seconds;  
 Pure bamboo, Anti-UV, Water-proof,  
 Heavy duty, Environmental, Adjustable height.

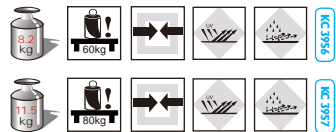

**COMPACT FOLDING TABLE**  
**便携折叠桌**  
**KC3866**

产品信息：  
 尺寸：107X70X70cm  
 材料：铝合金桌面/铁支架  
 特点：大尺寸，结实稳定，  
 安装容易，折叠后体积小，  
 装入外袋便于携带及存储。

Technical Specification:  
 Features:  
 Open and fold in seconds;  
 Super stable and durable;  
 Light weight;  
 Carry bag for ease of  
 transportation and storage.

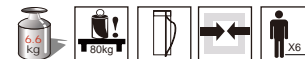

## MULTIFUNCTIONAL CAMPING EQUIPMENTS CART

## 百变野营装备车

## KC3922

产品信息：

尺寸：80x76x37cm

支架：铝合金

桌板：不锈钢板

特点：

- 1)功能多样：该产品集成了收纳箱、营地车、折叠桌三种功能于一体。  
 \* 收纳箱：可以收纳整理野营所需的装备及用品，如帐篷、睡袋、小款折叠椅等。  
 \* 营地车：从停车位到营地路途可当作拉杆箱使用，减轻人们的搬运负担。  
 \* 折叠桌：在营地将箱体可折叠部分展开，便可形成一张80x76公分的桌子，人们可以用来就餐和娱乐等。
- 2)折叠性强。该产品把户外家具的折叠性发挥到了极致。  
 收纳箱、桌面、桌腿、拖轮、拉杆均可折叠收起，最大限度的保证了收起后的小体积，和展开后的大用途。
- 3)材料结实耐用。该产品支架采用铝合金，桌面采用不锈钢材质，真材实料方能经得起户外长时间使用。

Technical Specification

Size: 80x76x37cm

Frame: Aluminum,

Material: Stainless table top

Features: Open and fold in seconds;

Multifunctional, it is not only a cart,

a wardrobe but also a table;

With wheel &amp; handle,

Easy for transportation &amp; storage.





## DELUXE ARMS CHAIR 豪华扶手椅

### KC3808

产品信息：  
尺寸：67x55x97cm  
面料：100%聚酯纤维加密高强度耐磨牛津布  
支架：高强度铝合金支架  
颜色：黑灰条纹  
特点：豪华，舒适，安装简单，轻便，易携带。

Technical Specification:  
Size: 67x55x97cm  
Fabric: Extra strength 1200D oxford cloth  
Frame: Aluminum  
Color: Black with grey stripe  
Features:  
Easy to assembly;  
Safe for use in all activities;  
Super comfortable;  
Storage pouch-beverage holder;  
Carry bag for ease of transportation & storage.



## DELUXE DIRECTOR CHAIR 豪华导演椅

### KC3821

产品信息：  
尺寸：87/62x54x41/84cm  
面料：1200D牛津布  
支架：铝管  
颜色：黑灰条纹  
特点：舒适便携，快速打开，承重大，侧桌、杯托。

Technical Specification:  
Size: 87/62x54x41/84cm  
Fabric: 1200D Oxford  
Frame: Aluminum  
Color: Black/Grey  
Features:  
Comfortable; Portable;  
Open and fold in seconds;  
Heavy duty;  
Side table and cup holder.



## ALUMINUM LYING CHAIR 铝合金躺椅

### KC3847

产品信息：  
尺寸：76X168X50/82cm  
面料：100%聚酯纤维加密高强度耐磨牛津布  
支架：高强度铝合金支架  
颜色：黑灰条纹  
特点：豪华，舒适，稳定性好，安装简便，易携带。

Technical Specification:  
Size: 76X168X50/82cm  
Fabric: Extra strength 1200D oxford cloth  
Frame: Aluminum  
Color: Black with grey stripe  
Features:  
Open and fold in seconds;  
Safe for use in all activities;  
Super comfortable;  
Storage pouch-beverage holder;  
Carry bag for ease of transportation & storage.



## DELUXE CAMPING BED

### 豪华铝制行军床

#### KC3806

产品信息：  
 尺寸：190x63x42cm  
 面料：100%聚酯纤维加密高强度耐磨牛津布  
 支架：高强度铝合金支架  
 颜色：黑灰条纹  
 特点：安装简单，舒适，轻便，易携带

Technical Specification:  
 Size: 190x63x42cm  
 Fabric: Extra strength 1200D oxford cloth  
 Frame: Aluminum  
 Color: Black with grey stripe  
 Features: Easy to assembly;  
 Super Comfortable;  
 Extra Stable; Light Weight;  
 Carry bag for ease of transportation & storage.



## STEEL FOLDING BED

### 折叠行军床

#### KC3940

产品信息：  
 尺寸：205x75x50cm  
 面料：100%聚酯纤维加密高强度耐磨牛津布  
 支架：高强度铁管支架，银黑双色喷塑  
 颜色：黑灰条纹  
 特点：安装简单，舒适，轻便，  
 稳定有安全锁扣，易携带

Technical Specification:  
 Size: 205x75x50cm  
 Fabric: Extra strength 1200D oxford cloth  
 Frame: steel tubes  
 Color: Black with grey stripe  
 Features:  
 Easy to assembly; Safe for use;  
 Super comfortable; Stable;  
 Light weight; Carry bag for  
 ease of transportation & storage.



## DELUXE STEEL ARM CHAIR

### 铁管豪华扶手椅

**KC3887**

产品信息:

尺寸: 67x60x47/102cm

面料: 100%聚酯纤维高强度耐磨牛津布

支架: 高强度铁管支架

颜色: 黑/灰

特点:

豪华, 舒适, 稳定性好, 配有冰包(保温包), 可放热水瓶、食物或冷饮等。安装简便, 易携带。

Technical Specification:

Size: 67x60x47/102cm

Fabric: 600x300D oxford

Frame: steel tubes

Color: Black/grey

Features:

Easy assembly; Safe for using;

Comfortable; Stable; With cooler bag.

Carry bag for ease of transportation & storage.



## DELUXE STEEL ARM CHAIR

### 铁管豪华扶手椅

**KC3888**

产品信息:

尺寸: 97/62x60x47/105cm

面料: 100%聚酯纤维高强度耐磨牛津布

支架: 高强度铁管支架

颜色: 黑/灰

特点: 豪华, 舒适, 稳定性好,

扶手处有杂志袋和冰包, 冰包可放热水瓶、食物或冷饮。安装简便, 易携带。

Technical Specification:

Size: 97/62x60x47/105cm

Fabric: 600x300D oxford

Frame: steel tubes

Color: Black/grey

Features: Easy assembly;

Safe for using; Comfortable;

Stable; Carry bag for ease of transportation & storage.



## HARD ARM CHAIR

### 铁管扶手椅

**KC3825**

产品信息:

尺寸: 59/53x83x46/95cm

面料: 600D牛津布

支架: 铁管

颜色: 黑灰色

特点:

硬扶手, 快速打开, 便携的, 承重大, 安装简单, 透气舒适。

Technical Specification:

Size: 59/53x83x46/95cm

Fabric: 600D Oxford

Frame: Steel

Color: Black/Gray

Features:

Hard Arm; Portable; Comfortable;

Light Weight; Heavy duty;

Open and fold in seconds; Breathable.



## DIRECTOR FOLDING CHAIR

### 导演椅

**KC3977**

产品信息:

尺寸: 110/53X58X44/95cm

面料: 100%聚酯纤维耐磨牛津布

支架: 铁管

颜色: 黑灰搭配

特点: 秒开, 豪华, 舒适, 易携带

Technical Specification:

Size: 110/53X58X44/95cm

Fabric: 100% Polyester

Frame: Steel

Color: Black/Gray

Features:

Open and fold in seconds;

Super Comfortable;

Lightweight;





## PORTABLE DIRECTOR CHAIR

### 便携导演椅

#### KC3824

产品信息：  
尺寸：83/60×50×44/92cm  
面料：600D牛津布  
支架：铁管  
颜色：黑灰色  
特点：硬扶手，便携的，结实耐用，  
安装简单，透气舒适。

Technical Specification:  
Size:83/60×50×44/92cm  
Fabric:600D Oxford  
Frame:Steel  
Color:Black/Gray  
Features:  
Hard Arm; Portable; Comfortable;  
Light Weight; Heavy duty;  
Open and fold in seconds; Breathable.



## TALL DIRECTOR CHAIR

### 高脚导演椅

#### KC3823

产品信息：  
尺寸：82/58×59×67/103cm  
面料：900D牛津布  
支架：铁管  
颜色：黑灰条纹  
特点：高坐高，可收纳脚蹬，  
侧桌和侧袋设计，舒适的，承重大。

Technical Specification:  
Size:82/58×59×67/103cm  
Fabric:900D Oxford  
Frame:Steel  
Color:Black/Gray Stripes  
Features:  
Tall seat height; Foldable footrest;  
Side table and storage bag;  
Portable; Comfortable.



## SOFA FOLDING CHAIR

### 沙发椅

#### KC3976

产品信息：  
尺寸：83x76x44/90cm  
面料：100%聚酯纤维耐磨牛津布夹棉  
支架：铁管  
颜色：黑灰搭配  
特点：秒开，豪华，超级舒适，易携带

Technical Specification:  
Size: 83x76x44/90cm  
Fabric:100% Polyester  
Frame: Steel  
Color:Black/Grey  
Features:  
Cotton seat and backrest for  
super comfortable;  
Extra durable



## DELUXE MOON CHAIR

### 豪华QQ休闲椅

#### KC3989

产品信息：  
尺寸：86x69x40/80cm  
面料：100%聚酯纤维高强度耐磨牛津布  
支架：高强度铁管支架  
颜色：黑/灰  
特点：豪华，舒适，稳定性好，后背处有  
杂志袋和冰包，可放热水瓶、食物或冷饮。  
安装简便，易携带。

Technical Specification:  
Size: 86x69x40/80cm  
Fabric: 600x300D oxford  
Frame: steel tubes  
Color: Black/grey  
Features: Easy assembly;  
Safe for using;  
Comfortable; Stable;  
Carry bag for ease of  
transportation & storage.





**LOW SLING CHAIR 矮背铁管折叠椅 KC3827**  
**TALL SLING CHAIR 高背铁管折叠椅 KC3837**

产品信息：  
 尺寸：60x54x35/75cm ( KC3827 )  
 65x54x35/91cm ( KC3837 )  
 材料：600D 牛津布  
 支架：铁管  
 颜色：咖啡色  
 特点：舒适，快速打开，可折叠，便携。  
 Technical Specification:  
 Size:60x54x35/75cm(KC3827)  
 65x54x35/91cm(KC3837)  
 Material:600D Oxford  
 Frame:Steel  
 Color:Brown  
 Features:  
 Comfortable, Open and fold in seconds,  
 Portable Carry bag for transportation and storage.



**STEEL FOLDING CHAIR**  
**簸箕椅**  
**KC3975**

产品信息：  
 尺寸：62x55x34/66cm  
 面料：600D牛津布  
 支架：铁管  
 颜色：橙色  
 特点：秒开，美观时尚，  
 舒适耐用，易携带  
 Technical Specification:  
 Size: 62x55x34/66cm  
 Fabric:100% Polyester  
 Frame: Steel  
 Color:Orange  
 Features:  
 Open and fold in seconds;  
 Easy to carry  
 Lightweight;



NEW

## ARM QUAD CHAIR L 大号铁管扶手椅

**KC3828**

产品信息：  
尺寸：85x60x43/100cm  
面料：600x300D牛津布  
支架：铁管  
颜色：蓝色/灰色/红色  
特点：舒适便携，快速打开，  
承重大，冰包、侧袋、杯托。

Technical Specification:  
Size:85x60x43/100cm  
Fabric:600x300D Oxford  
Frame:Steel  
Color:Blue/Gray/Red  
Features:  
Portable; Comfortable;  
Open and fold in seconds;  
Heavy duty; Cooler bag;  
Storage and cup holder.



## COMFORT MOON CHAIR L 大号舒适QQ椅

**KC3816**

产品信息：  
尺寸：84x70x40/80cm  
面料：100%聚酯纤维高强度耐磨牛津布  
支架：铁管  
颜色：蓝、绿、红  
特点：  
美观时尚，舒适耐用；  
快速打开，使用方便；  
有杯套；提袋设计，便于携带；  
后背杂志袋，户外家庭都能用。

Technical Specification:  
Size:84x70x40/80cm  
Fabric:600D Oxford  
Frame:Steel  
Color:Blue/Green/Red  
Features:  
Fashionable color;  
Comfortable;Extra durable;  
Open and fold in seconds;  
Cup holder;  
Carry bag for transportation and storage;



NEW



## ARMS CHAIR IN STEEL 铁管扶手椅

### KC3818

产品信息：  
尺寸：84x50x44/96cm  
面料：100%聚酯纤维高强耐磨牛津布  
支架：铁管  
颜色：蓝色，红色，绿色  
特点：美观时尚，舒适，  
轻便，易携带，性价比高。

Technical Specification:  
Size: 84x50x44/96cm  
Fabric: 600x300D oxford  
Frame: steel tubes  
Color: Blue-Red-Green  
Features: Fashionable colors;  
Safe for using; Comfortable;  
Carry bag for ease  
of transportation & storage.



## COMPACT CHAIR M 小号连体椅

### KC3802

产品信息：  
尺寸：40x40x34/57cm  
面料：100%聚酯纤维高强耐磨牛津布  
支架：高强度铝合金支架  
颜色：蓝/红/绿  
特点：美观时尚，舒适，轻便，  
易携带，性价比高。

Technical Specification:  
Size: 40x40x34/57cm  
Fabric: 600x300D Oxford  
Frame: Aluminum  
Color: Blue-Red-Green  
Features: Fashionable colors;  
Safe for using; Comfortable; Light weight;  
Carry bag for ease of transportation and storage.



## COMPACT CHAIR L 铝管连体休闲椅

### KC3801

产品信息：  
尺寸：50x50x45/73 cm  
面料：100%聚酯纤维  
加密高强度耐磨牛津布  
支架：高强度铝合金支架  
颜色：绿黑色条纹+绿色  
特点：舒适，安装简单，轻便，易携带。

Technical Specification:  
Size: 50x50x45/73 cm  
Fabric: Extra strength 1200D oxford cloth  
Frame: Aluminum  
Color: Green with black stripe  
Features: Open and fold in seconds;  
Safe for using; Comfortable; Light Weight;  
Carry bag for ease of transportation  
and storage.



## ALUMINUM FOLDING CHAIR 绿灰条扶手椅

### KC3803

产品信息：  
尺寸：83x54x43/78cm  
面料：100%聚酯纤维加密高强度耐磨牛津布  
支架：高强度铝合金支架  
颜色：绿黑色条纹+绿色  
特点：使用方便，舒适耐用，轻便，易携带。

Technical Specification:  
Size: 83x54x43/78cm  
Fabric: Extra strength 1200D oxford cloth  
Frame: Aluminum  
Color: Green with black stripe  
Features: Open and fold in seconds;  
Safe for using; Comfortable; Light Weight;  
Carry bag for ease of transportation  
and storage.



## ALUMINUM COMPACT BED 铝管便携折叠床

### KC3857

产品信息：  
尺寸：190x61x38/52cm  
面料：100%聚酯纤维加密高强度耐磨牛津布  
支架：高强度铝合金支架  
颜色：绿黑色条纹+绿色  
特点：  
舒适，安装简单，轻便，易携带。

Technical Specification:  
Size: 190x61x38/52cm  
Fabric: Extra strength  
1200D oxford cloth  
Frame: Aluminum  
Color: Green with black stripe  
Features:  
Open and fold in seconds;  
Safe for using; Comfortable;  
Light Weight; Carry bag for  
ease of transportation and storage.



## FREE - ADJUSTMENT DECKCHAIR(COOL STYLE)

### 自由调节躺椅-清凉舒适版

#### KC3902

产品信息:

尺寸: 165X65X112CM

支架: 铁管

面料: 特斯林网布

颜色: 灰色

特点:

椅背角度可自由调节, 在可调范围内可随意固定。

用脚踏脚踏即可实现后仰, 整个椅面曲线按人体工学设计,

在最大角度时(靠背155度), 膝盖微曲,

小腿高于臀部, 头部保持微上扬,

此姿势可促进血液循环, 保持呼吸顺畅,

也是最舒适的睡眠姿势, 非常适合午休小憩。

布面和支架用高弹皮筋绳串连,

比布面车缝套在支架上舒适。

枕头用皮筋绳套在椅背, 可根据体型上下调节高度。

Technical Specification

Size: 165X65X112CM

Frame: Iron

Fabric: Textilene

Color: Grey

Features: Comfortable.

Free adjustment.

Ergonomically Designed.

Removable pillow.



## FREE - ADJUSTMENT DECKCHAIR(ENLARGED STYLE)

### 自由调节躺椅-加宽夹棉版

#### KC3903

产品信息:

尺寸: 165X70X112cm

支架: 铁管

面料: 600D双层牛津布夹海棉2cm

颜色: 黑色

特点:

椅背角度可自由调节, 在可调范围内可随意固定。

用脚踏脚踏即可实现后仰, 整个椅面曲线按人体工学设计,

在最大角度时(靠背155度), 膝盖微曲, 小腿高于臀部,

头部保持微上扬, 此姿势可促进血液循环, 保持呼吸顺畅,

也是最舒适的睡眠姿势, 非常适合午休小憩。

Technical Specification:

Size: 165X70X112cm

Frame: Iron

Fabric: Polyester/ Foams

Color: Black

Features: Comfortable . Free adjustment.

Ergonomically Designed. Strong and steady frame.





## ADJUSTABLE LOUNGE CHAIR

### 特斯林多功能休闲躺椅

#### KC3932

产品信息：  
尺寸：163/175×65×44/70cm  
面料：特斯林网布  
支架：铁管  
颜色：黑色

特点：  
四档位可调节，多功能，可拆卸枕头，  
承重能力强，特斯林布料，结实耐用，  
简单组装，方便使用，便于携带存储。

Technical Specification:  
Size:163/175×65×44/70cm  
Fabric:Textilene  
Frame:Steel  
Color:Black  
Features:  
4-Position; Multifunction;  
Removable pillow;  
Textilene fabric, Aluminum structure;  
Comfortable; Open and fold in seconds;  
Portable, Heavy duty.



## ADJUSTABLE CAMPING COT

### 可调三折床

#### KC3913

产品信息：  
 尺寸：190x60x30cm  
 面料：600D牛津布  
 支架：铁管  
 颜色：蓝色  
 特点：  
 悬挂系统，舒适便携，快速打开，承重大。

Technical Specification:  
 Size:190x60x30cm  
 Fabric:600D Oxford  
 Frame:Aluminum  
 Color:Blue  
 Features:  
 Suspension System; Comfortable;  
 Portable; Open and fold in seconds;  
 Heavy duty.



## SUSPENSION FOLDING CHAIR

### 折叠椅

#### KC3927

产品信息：  
 尺寸：64x61x90cm  
 面料：600D牛津布  
 支架：铁管  
 颜色：蓝色  
 特点：  
 悬挂系统，舒适便携，快速打开，承重大。

Technical Specification:  
 Size:64x61x90cm  
 Fabric:600D Oxford  
 Frame:Steel  
 Color:Blue  
 Features:  
 Suspension System; Comfortable;  
 Portable; Open and fold in seconds;  
 Heavy duty.



## ARMYMAN CAMPING BED

### 行军床

#### KC3806A

产品信息：  
 尺寸：190x63x42cm  
 面料：100%聚酯纤维高强度耐磨牛津布  
 支架：铁管  
 颜色：军绿色、蓝色、米色  
 特点：舒适，轻便，易携带，性价比高。

Technical Specification:  
 Size: 190x63x42cm  
 Fabric: 600x300D oxford  
 Frame: Steel  
 Color: green/blue/beige  
 Features:  
 Easy assembly; Safe for using;  
 Comfortable; Stable; Light weight.  
 Carry bag for ease of transportation and storage.



## HARD CAMPING COT L

### 大号铁管行军床

#### KC3039

产品信息：  
 尺寸：205x75x46cm  
 面料：600D牛津布  
 支架：铁管  
 颜色：军绿色  
 特点：  
 承重能力强，舒适的，简单组装，  
 方便使用，便于携带存储。

Technical Specification:  
 Size: 205x75x46cm  
 Fabric: 600D Oxford  
 Frame: Steel  
 Color: Green  
 Features:  
 Heavy duty; Comfortable;  
 Open and fold in seconds;  
 Portable. Carry bag for transportation and storage.





## FOLDING BED 速开折叠床

### KC8005

产品信息：  
尺寸：190x68x48cm  
面料：600D双层牛津布  
支架：铁管  
颜色：绿色、蓝色、灰色  
特点：  
十支点支撑，承重好；  
可折叠，有外袋，  
携带方便；有侧兜。

Technical Specification:  
Size:190x68x48cm  
Fabric:600D Oxford  
Color:Green/Blue/Grey  
Features:  
Open & fold easily;  
Ten feet ensure good bearing capacity;  
Side pockets.



NEW



## DELUXE FOLDING BED 豪华速开折叠床

### KC8006

产品信息：  
尺寸：190x68x48cm  
面料：双层牛津布（上层1200D下层600D）  
支架：铁管  
颜色：绿色  
特点：  
十支点支撑，承重好；  
可折叠，有外袋，携带方便；有侧兜。

Technical Specification:  
Size:190x68x48cm  
Fabric:600D Oxford  
Color:Green  
Features:  
Open & fold easily;  
Ten feet ensure good bearing capacity;  
Side pockets.



NEW



## ALUMINUM ROLLING TABLE

### 铝制折叠桌

#### KC3961

产品信息：  
尺寸：70X70X69cm  
材料：铝合金  
特点：  
安装方便，稳定性强  
轻便；易携带

Technical Specification  
Size: 70X70X69cm  
Material: Aluminum  
Features:  
Easy assembly;  
Stable  
Light weight  
Easy to carry



## ALUMINUM ROLLING TABLE

### 铝折台

#### KC3861

产品信息：  
尺寸：70x70x70cm  
材料：铝合金  
特点：  
安装方便，稳定性强，  
轻便，易携带。

Technical Specification:  
Size: 70x70x70cm  
Material: aluminum  
Feature:  
Easy assembly, Stable,  
Light weight, Easy carrying.



## DELUXE PICNIC TABLE/CHAIR SET

### 铝凳面连体台

#### KC3864

产品信息：  
尺寸：136x86x67cm  
材料：桌面：  
中密度纤维板；  
凳面：铝合金  
支架：铝合金  
特点：产品折叠后体积小，  
4个小凳子可放在桌面内收藏，  
非常方便携带及存放。

Technical Specification:  
Size: 136x86x67cm  
Frame and chair:  
aluminum and MDF table top  
Table surface: MDF  
Features:  
Open and folds in seconds;  
Luggage-style carrying case for  
ease of transportation and storage.



## 3-FOLD ALUMINUM TABLE

### 三折铝木台

#### KC3853

产品信息：  
尺寸：120x80x70cm  
支架：高强度铝合金支架  
材料：中密度纤维板  
特点：安装方便，轻便，  
折叠后体积小，方便实用。

Technical Specification:  
Size: 120x80x70cm  
Frame: Aluminum  
Material: MDF table board  
Features:  
Easy to assembly;  
Light weight;  
small packed size for easy carrying.



## COMPACT FOLDING TABLE

### 便携折叠桌

#### KC3815

尺寸：100X70X44/68CM  
 支架：铝合金  
 特点：安装方便，  
 稳定性好，两种高度，  
 折叠后体积小，方便使用。

SIZE: 100X70X44/68CM

Frame: Aluminum

Feature:

Open and fold in seconds,  
 two adjustable heights, stable,  
 light weight, easy carrying



## ALUMINUM TABLE AND CHAIR SET

### 桌椅分体组合台

#### KC3850

产品信息：  
 桌子尺寸：100x70x44/68cm  
 椅子尺寸：32X30X40cm  
 支架：高强度铝合金支架  
 材料：中密度纤维板; 100%聚酯纤维高强耐磨牛津布  
 特点：  
 安装方便，稳定性好，两种高度，折叠后体积小，方便实用。

Technical Specification:

Table size:100X70X44/68cm

Chair size:32X30X40cm

Frame: Aluminum

Material: MDF table top;600X300D oxford for chair

Features:

Open and fold in seconds, Two adjustable heights,  
 Stable, Light weight, Easy carrying.





## MOON CHAIR S

## 儿童QQ椅

## KC3833

产品信息：

尺寸：51x42x28/52cm

面料：600x300D 牛津布

支架：铁管

颜色：蓝色，绿色

特点：

专为儿童设计，增加安全锁扣，

使用安全，轻便易携带，

适合使用年龄：4-10岁

Technical Specification:

Size:51x42x28/52cm

Fabric:600x300D Oxford

Frame:Steel

Color:Blue/Green

Features:

Safe lock design; Comfortable;

Carry bag for transportation and storage;

Suitable for 4-10 years old children.



## QUAD CHAIR S

## 儿童扶手椅

## KC3898

产品信息：

尺寸：56/34x34x27/60cm

面料：600x300D 牛津布

支架：铁管

颜色：蓝色，绿色

特点：

专为儿童设计，舒适的，

使用安全，轻便易携带，

适合使用年龄：4-10岁。

Technical Specification:

Size:51x42x28/52cm

Fabric:600x300D Oxford

Frame:Steel

Color:Blue/Green

Features:

Safe for using; Comfortable;

Carry bag for transportation and storage;

Suitable for 4-10 years old children.



## KIDS CARTON ARMCHAIR

## 青蛙儿童椅

## KC3897

产品信息：

尺寸：57x34x60cm

面料：100%聚酯纤维耐磨牛津布

支架：铁管

颜色：绿色

产品特点：

专为儿童设计，安全，轻便，

易携带，适合使用年龄3-7岁

Technical Specification:

Size:57x34x60cm

Fabric:100% Polyester

Frame:Steel

Color:Green

Features:

Design for 3-7 years old children

Easy to carry

Safe for using

Comfortable



## FOUR LEGS STOOL

### 四腿折凳

#### KC3868

产品信息:

尺寸: 34x34x46cm

面料: 100%聚酯纤维高强度耐磨牛津布

支架: 高强度铁支架

颜色: 灰色

特点:

安全便捷, 舒适耐用, 稳定性强。

Technical Specification:

Size: 34x34x46cm

Fabric: 600x300D oxford

Frame: steel tubes

Color: Grey

Features:

No assembly required,

Light weight and easy to carry.



## ALUMINUM FOLDING STOOL

### 铝制小马扎

#### KC3836

产品信息:

尺寸: 34x30x42cm

面料: 100%聚酯纤维高强度耐磨牛津布

支架: 高强度铝合金支架

颜色: 蓝色

特点: 超轻量化便于携带,

可与铝木台KC3815配套使用。

Technical Specification:

Size: 34x30x42cm

Fabric: 600x300D oxford

Frame: Aluminum

Color: Blue

Features:

No assembly required,

Light weight and easy to carry.



## 360° SWIVEL ULTRA LIGHT CHAIR

### 超轻旋转椅

#### KC3951S

产品信息:

尺寸: 55x58x38/70cm

面料: 尼龙

支架: 航空铝7075

旋转连接件, 加强压铸铝

特点:

超轻, 耐用, 便携,

折叠后体积小巧,

可随身携带, 旋转,

360°旋转,

使用方便有趣。

Technical Specification:

Size: 55x58x38/70cm

Fabric: Nylon

Frame: Aluminum

Features:

Lightweight;

Stable; Comfortable;

Carry bag for easy carrying

360° Rotation.



## 360° SWIVEL ULTRA LIGHT CHAIR

### 超轻旋转椅

#### KC3952

产品信息:

尺寸: 55x58x38/70cm

面料: 聚酯纤维

支架: 航空铝

特点:

超轻, 折叠, 便携;

360°旋转, 弯管。

Technical Specification:

Size: 55x58x38/70cm

Fabric: Nylon

Frame: Aluminum

Features:

Light weight;

Stable; Comfortable;

Carry bag; 360° Rotation.



## 360° SWIVEL ULTRA LIGHT HIGHCHAIR

## 高脚旋转椅

## KC3983

产品信息：  
 面料：尼龙  
 支架：航空铝7075，旋转连接件  
 特点：加高支架，使用更舒适  
 超轻，耐用，便携，  
 折叠后体积小，可随手携带，  
 旋转，360度旋转，使用方便有趣

Technical Specification:  
 Size: 55x58x48/80cm  
 Fabric: Nylon  
 Frame: Aluminum  
 Features: Lightweight;  
 Stable, Comfortable;  
 Carry bag for easy carrying  
 Rotation; High seat



## HIGH-BACKED FOLDING CHAIR

## 可调节高背椅

## KC3950

产品信息：  
 尺寸：58 x 90 x 36/99cm  
 面料：600D牛津布  
 支架：铝合金  
 特点：  
 全铝支架，轻便，  
 15°可调节椅背，使用更舒适  
 收纳体积小，随手携带。

Technical Specification:  
 Size: 58 x 90 x 36/99cm  
 Fabric: 600D oxford cloth  
 Frame: Aluminum  
 Features:  
 Ultra light; Comfortable;  
 Full-Alu; Portable; adjustable;  
 Carry bag for ease of  
 transportation and storage.



## ULTRALIGHT CHAIR

## 经典超轻椅

## KC3939

产品信息：  
 尺寸：52x53x36/67cm  
 面料：1200D牛津布  
 支架：铝管  
 颜色：灰色  
 特点：  
 超轻，携带方便，快速打开，  
 承重大，安装简单，舒适。

Technical Specification:  
 Size: 52x53x36/67cm  
 Fabric: 1200D Oxford  
 Frame: Aluminum  
 Color: Gray  
 Features:  
 Ultra light; Portable;  
 Comfortable; Heavy duty;  
 Open and fold in seconds.



## ULTRA LIGHT FOLDING CHAIR

## 加高高背椅

## KC3984

产品信息：  
 面料：600D牛津布  
 支架：铝合金  
 特点：加高支架，使用更舒适  
 超轻，耐用，便携，  
 折叠后体积小，可随手携带，

Technical Specification:  
 Size: 55x55x83cm  
 Frame: Aluminum  
 Fabric: 600D Oxford  
 Features: Ultra light; Comfortable;  
 Full-Alu; Portable;  
 Carry bag for ease of transportation  
 and storage.





## ULTRA LIGHT ARM CHAIR

### 超轻扶手椅

#### KC3985

产品信息：  
尺寸：66.5x83.5x100cm  
面料：600D牛津布  
支架：铝合金  
特点：  
扶手设计，使用更舒适  
超轻，耐用，便携，  
折叠后体积小，可随身携带。

Technical Specification:  
Size:66.5x83.5x100cm  
Frame:Aluminum  
Fabric:600D Nylon  
Features:  
Ultra light,Comfortable;  
Full-Alu;Portable;  
Carry bag for ease of  
transportation and storage.



## ULTRA-LIGHT ALU.FOLDING STOOL

### 超轻铝四角凳

#### KC3918

产品信息：  
材质：航空铝6061  
尺寸：20X20X23cm  
面料：600D双色交织布  
特点：  
轻便，小巧，精致，亮丽，可爱。

Technical Specification:  
Size:20X20X23cm  
Fabric:Extra strength 900D oxford cloth  
Frame:Aircraft-grade Aluminum  
Color:Black  
Features:  
Ultra light. Portable.  
Carry bag for ease of  
transportation and storage.



## ULTRA-LIGHT FOLDING STOOL

### 超轻铝折叠马扎

#### KC3916

产品信息：  
尺寸：20X22X27cm  
面料：900D牛津布 + 网兜  
支架：航空铝6063 (表面氧化)  
特点：超轻铝材质，  
有网兜方便装日常用品。  
凳面背面有两根织带，增强承重能力。  
铝管可插拔折叠，  
折叠后只有平放的三分之一大小，  
配有拎袋，非常便携。

Technical Specification:  
Size: 20X22X27cm  
Fabric: Extra strength 900D oxford cloth  
Frame: Aircraft-grade Aluminum  
Color:Black  
Features: Ultra light. Easy fold and open.  
Net pocket for putting sundries.Portable.  
Carry bag for ease of transportation and storage.



## ULTRALIGHT FOLDING TABLE

### 超轻布面折叠桌

#### KC3930

产品信息：  
尺寸：56x42.5x40cm  
面料：1000D牛津布  
支架：铝管  
颜色：灰色  
特点：  
超轻，折叠后体积小，便携性强，  
组装简单，桌面平整。

Technical Specification:  
Size:56x42.5x40cm  
Fabric:1000D Oxford  
Frame:Steel  
Color:Grey  
Features:  
Ultra light; Portable;  
Rolling up table top;  
Open and fold in seconds;  
Carry bag for ease of transportation and storage.



## ULTRA - LIGHT FOLDING TABLE L

### 大号超轻布面桌

#### KC3945

产品信息：

尺寸：80x57x56cm

支架：超轻铝

面料：彩色尼龙

特点：相对于KC3920，开创性的增加了四根竖管（伸缩管）使得桌子的稳定性和承重能力大大增强。桌面牛津布内装有铝板，开口处魔术贴封口，铝板可抽出。桌面两端有拉链，使用时可以把两张桌子拼接在一起，适合人多时候使用，非常方便和人性化。

Technical Specification:

Size:80x57x56cm

Frame: Aircraft-grade Aluminum

Fabric: Extra strength 600D oxford cloth

Features:Ultra light; Particular structure ensure the stability of the frame,Portable. Carry bag for ease of transportation and storage.



## ULTRA - LIGHT FOLDING TABLE S 超轻全铝桌小号 KC3924

## ULTRA - LIGHT FOLDING TABLE L 超轻全铝桌大号 KC3925

产品信息：

尺寸：39.5x34.5x32cm ( KC3924 )

56x41x40cm ( KC3925 )

支架/桌面：航空铝

颜色：咖色

特点：超轻，便携，精致。

Technical Specification:

Size: 39.5x34.5x32cm(KC3924)

56x41x40cm(KC3925)

Frame: Alu.

Color:brown

Features:

Ultra light. Portable.

Carry bag for ease of transportation and storage



## ULTRALIGHT CAMPING COT

### 超轻床

#### KC3986

产品信息：

尺寸：190x64x12cm

面料：420D牛津布

支架：铝管

颜色：蓝色，绿色，黑色，灰色，橙色

特点：

超轻重量，快速打开，方便使用，折叠尺寸小，便于携带存储，承重能力强。

Technical Specification:

Size:190x64x12cm

Fabric:420D Oxford

Frame:Aluminum

Color:Blue, Green,Black, Grey,Orange

Features:

Ultra Light;Open and fold in seconds;

Portable,Heavy duty;

Small size after folding;

Carry bag for transportation and storage.



## BEACH/CAMPING CART

### 沙滩/营地车

#### KC3909

产品信息：  
尺寸：93×51×57cm  
布料：600×300D牛津布  
支架：铁管  
颜色：红色

特点：  
小车自身容积大，收起后体积小，  
可拎可拉，携带方便。支架稳固。

Technical Specification:  
Size:93×51×57cm  
Fabric:600×300D Oxford  
Frame:Iron tubes

Features:  
Big storage room;  
Easy to open and fold;  
Adjustable handle;  
Specially designed for transportation  
and storage of camping stuff on beach.



## LUGGAGE FOLDING CART

### 折叠行李车

#### KC3908

产品信息：  
支架材质：铝合金  
车轮材质：PP, TPR  
展开尺寸：101×39×41cm  
折叠尺寸：65×39×5.5cm  
颜色：黑色

收纳方式：四面折叠收纳  
特点：  
可折叠收纳。自带弹力绳，防止行李脱落。  
拉杆可伸缩，车轮可折叠收纳。

Technical Specification:  
Frame material: Aluminum  
Wheel material: PP, TPR  
Open size:101×39×41cm  
Close size:65×39×5.5cm

Features:  
\* Elastic included to secure your carry items;  
\* Folds flat to only 2.2" thick for easy storage and transportation;  
\* Telescoping handle extends to 40".









## COOLER BAG 5L

### KG3795

产品信息：  
 面料：100%聚酯纤维（防帆布面料）  
 里料：100%聚酯纤维  
 附件：铝膜保温层，头层牛皮主标和拉唛  
 容积：5L  
 特点：  
 小巧轻便，多个分仓，易清洁，易储存，  
 适合户外野餐、日常携带工作餐使用。

Technical Specification:  
 Material: 100% polyester  
 Volume: 5L  
 Feature: easy to take, more pocket,  
 easy cleaning and storage,  
 for outdoor food pack, day pack.



## COOLER BAG 10L

### KG3796

产品信息：  
 面料：100%聚酯纤维（防帆布面料）  
 里料：100%聚酯纤维  
 附件：铝膜保温层，头层牛皮主标和拉唛  
 容积：10L  
 特点：小巧轻便，可手拎或单肩背，  
 易清洁，易储存，适合户外野餐、  
 日常携带工作餐使用。

Technical Specification:  
 Material: 100% polyester  
 Volume: 10L  
 Feature:  
 easy to take, more pocket,  
 easy cleaning and storage,  
 for outdoor food pack, day pack.



## COOLER BAG 15L

### KG3797

产品信息：  
 面料：100%聚酯纤维（防帆布面料）  
 里料：100%聚酯纤维  
 附件：铝膜保温层，头层牛皮主标和拉唛  
 容积：15L  
 特点：多个分仓，  
 大容量保温储物空间，  
 易清洁，易储存，适合户外野餐使用。

Technical Specification:  
 Material: 100% polyester  
 Volume: 15L  
 Feature: more pocket,  
 large insulated cooler compartment,  
 easy cleaning and storage,  
 for outdoor food pack.



## COOLER BAG - 4 PERSON

### KG3798

产品信息：  
 面料：100%聚酯纤维（防帆布面料）  
 里料：100%聚酯纤维  
 附件：铝膜、PVC双层保温层，  
 头层牛皮主标和拉唛  
 配件：4只高脚杯、4把餐刀、4把汤勺、  
 4把餐叉、4只餐盘、1把牛排刀、  
 1个多功能启瓶器、1只调味瓶、  
 1块塑料砧板、1块桌布、4块餐巾  
 特点：多个分仓，大容量保温储物空间，  
 易清洁，易储存，适合家庭户外野餐使用。

Technical Specification:  
 Material: 100% polyester  
 Accessories:  
 4 goblets, 4knives, 4spoons,  
 4 forks, 4 plates, 1 steak knife,  
 1 multifunction bottle opener,  
 1salt & pepper pot,  
 1 chopping block,  
 1 table cloth, 4facial napkins.  
 Feature: more pocket,  
 large insulated cooler compartment,  
 easy cleaning and storage,  
 for outdoor food pack.



## PICNIC BLANKET

### 摇粒绒野餐垫

#### KG4701

产品信息：  
 尺寸：200x178cm  
 材质：摇粒绒、海绵、PEVA  
 颜色：棕色/红色/绿色  
 特点：手提包式设计，方便携带，上盖有拉链口的储物袋。  
 摇粒绒表面柔软舒适，不掉毛，对皮肤无害，使用安全健康。  
 PEVA底层，防水防潮。  
 适用于野餐休息。

Technical Specification:  
 Size: 200x178cm  
 Materials: Polar fleece  
 Color: Brown/Red/Green  
 Features: Handbag style design;  
 Storage bag with zipper;  
 Polar fleece is soft and comfortable, safe to skin.  
 Bottom layer PEVA, damp proof.

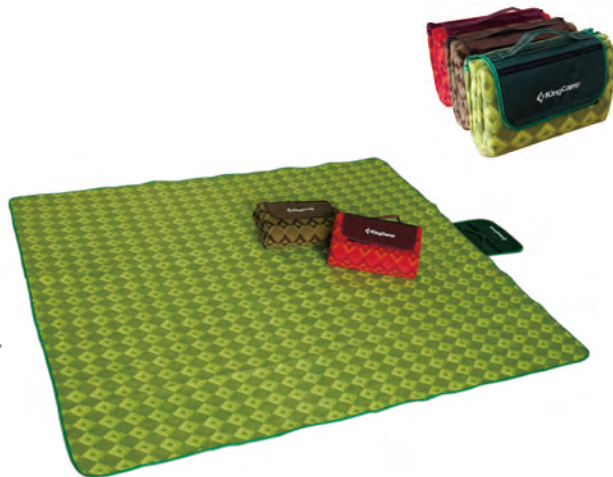

## PICNIC BLANKET

### 摇粒绒野餐垫

#### KG4702/KG4703/KG4704

产品信息：  
 尺寸：200x175cm(KG4702)  
 200x200cm(KG4703)  
 300x300cm(KG4704)  
 材质：摇粒绒  
 颜色：青色  
 特点：手提式设计，方便携带  
 摇粒绒表面柔软舒适，不掉毛  
 对皮肤无害，使用安全健康。  
 防水防潮，适用于野餐休息。

Technical Specification:  
 Size: 200x175cm(KG4702)  
 200x200cm(KG4703)  
 300x300cm(KG4704)  
 Material: Fleece  
 Features:  
 Handbag style design for easy carrying.  
 Soft and comfortable feeling fleece,  
 safe for your skin. Damp proof,  
 ideal for picnic.



## BBQ OVEN

### 大号日式烤炉

#### KG2711

产品信息：  
 尺寸：66x30.5x58/70cm  
 材料：冷轧薄钢板  
 颜色：黑色  
 包装：彩盒  
 特点：使用安全，结实耐用，  
 安装方便，易清洁，易保存  
 适宜人数：6-8人

Technical Specification:  
 Size: 66x30.5x58/70cm  
 Materials: steel sheet  
 Color: Black  
 Packing: color box  
 Features:  
 Safe for using;  
 Heavy duty stamped steel body,  
 Easy assembly and packing,  
 Easy cleaning and storage.



## BBQ OVEN

### 中号日式烤炉

#### KG2712

产品信息：  
 尺寸：49x30.5x48/60cm  
 材料：冷轧薄钢板  
 颜色：黑色  
 包装：彩盒  
 特点：使用安全，结实耐用，  
 安装方便，易清洁，易保存  
 适宜人数：4人

Technical Specification:  
 Size: 49x30.5x48/60cm  
 Materials: Steel sheet  
 Color: Black  
 Packing: color box  
 Features:  
 Safe for using;  
 Heavy duty stamped steel body,  
 Easy assembly and packing,  
 Easy cleaning and storage.





## VEHICULAR PORTABLE GRILL 车载手提式烤炉

### KG2721

产品信息：  
尺寸：60X38X65cm  
材料：不锈钢  
颜色：银色  
包装：彩盒  
特点：易清洁，拆装方便，  
实用性强，时尚美观  
适宜人数：4人

Technical Specification:  
Size: 60X38X65cm  
Material: Stainless steel  
Color: Silver  
Packing: color box  
Features:  
Easy assembly and carrying;  
Fashionable and suitable for self-driving  
tour and outdoor party use.



## PORTABLE GRILL 不锈钢便携烤炉

### KG2725

尺寸：56X33X68cm  
材料：不锈钢  
颜色：银色  
包装：彩盒  
特点：  
易清洁，拆装方便，  
实用性强，时尚美观  
适宜人数：6-8人。

Technical Specification:  
Size: 56X33X68cm  
Material: Stainless steel  
Color: Silver  
Packing: oxford carry bag and color box  
Features:  
Easy assembly and carrying,  
Fashion and suitable for self-driving  
tour and outdoor party use.



## RED PORTABLE GRILL 小/中号红色便携烤炉

### KG2743 / KG2744

产品信息：  
尺寸：45X30X70CM(KG2743)  
63X30X70CM(KG2744)  
材料：冷轧钢板  
颜色：红色  
特点：易清洁，拆装方便，  
自带挂钩和挂网，方便实用。

Technical Specification:  
Technical Specification:  
Size: 45X30X70CM(KG2743)  
63X30X70CM(KG2744)  
Material: Steel sheet  
Color: Red  
Packing: Color Box.  
Features:  
Easy assembly and cleaning,  
have hook and net parts,  
suitable for self-driving tour  
and outdoor party use.



## GAS STOVE 便携卡式炉

### KA2933

产品信息：  
材料：冷轧钢和压铸铝  
产品尺寸：335x290x88mm  
耗气量：168g/hr  
产品特点：  
理想的户外野营烹饪工具，  
预设安全系统，放心使用，  
手提箱式外包装方便携带和存放。

Specification:  
Material:  
Cold rolled steel and cast aluminum  
Size: 335x290x88mm  
Gas consumption: 168g/h  
Feature:  
Ideal for Camping & Outdoor cooking.  
Safety control system, free to use.  
Packed in PP case,  
easy to carry and store.



## MINI GAS STOVE 迷你卡式炉

### KG2760

产品信息：  
材质：铸铝，不锈钢  
产品尺寸：245×203×100mm  
燃气消耗量：140g/h  
颜色：银色  
产品特点：  
体积小巧；安全过压切断装置；  
铸铝炉芯，双重火焰，沸点均匀；  
挡风板可提高热效率；不锈钢炉面，  
持久耐用，方便清洁；火力可调节。

Technical Specification:  
Main material: Aluminum, Stainless steel  
Size: 245×203×100mm  
Gas consumption: 140g/h  
Color: SILVER  
Feature:  
MINI size; Safety shut-off device;  
Outer flame burner & inner flame burner;  
Windshield increases heat efficiency;  
Adjustable heat range, from boil to simmer.



## COMPACT GAS STOVE 便携卡式炉

### KG2761

产品信息：  
材质：铸铝，不锈钢  
产品尺寸：303×249×95mm  
燃气消耗量：130g/h  
颜色：棕色  
产品特点：  
结构精致；铸铝炉芯，  
火焰稳定强劲；挡风板可提高热效率；  
不锈钢炉面，持久耐用，  
方便清洁；火力可调节。

Technical Specification:  
Main material: Aluminum, Stainless steel  
Size: 303×249×95mm  
Gas consumption: 130g/h  
Color: BROWN  
Feature:  
Windshield increases heat efficiency;  
Adjustable heat range,  
from boil to simmer.



## CERAMIC GAS STOVE 陶瓷卡式炉

### KG2762

产品信息：  
材质：铸铝，不锈钢  
尺寸：326×277×91mm  
规格（燃气消耗量）：125g/h  
颜色：黑色  
产品特点：陶瓷燃烧红外线表面，  
火焰稳定，受热均匀，节省能源、  
热效率高，有利于身体健康；  
挡风板可提高热效率；火力可调节。

Technical Specification:  
Main material: Aluminum, Stainless steel  
Size: 326×277×91mm  
Gas consumption: 125g/h  
Color: BLACK  
Feature: Ceramic combustion  
surface make stable flame;  
Infrared prevents flare-up and  
spillover; Healthy heat.



## BASIC GAS STOVE 经典卡式炉

### KG2763

产品信息：  
材质：铸铝，冷轧钢  
产品尺寸：343×284×113mm  
燃气消耗量：160g/h  
颜色：银黑色  
产品特点：  
凹凸起伏的纹路，彰显雄厚质感；  
火焰稳定强劲，受热均匀；  
挡风板可提高热效率；火力可调节。

Technical Specification:  
Main material: Aluminum, Stainless steel  
Size: 303×249×95mm  
Gas consumption: 130g/h  
Color: SILVER BLACK  
Feature:  
Windshield increases heat efficiency;  
Adjustable heat range, from boil to simmer.



## DETACHABLE COOKING SET 可拆卸烧烤工具

### KG2726

产品信息：  
尺寸：32x22.5x5.5cm  
材料：不锈钢工具大身，聚丙烯手柄  
颜色：银色  
配件：2支手柄；1支叉；1支铲；1支夹；1支锯刀；  
1支刀；1个汤勺；1个开瓶器；2个胡椒瓶；  
包装：牛津布袋  
特点：  
易清洁，拆装方便，  
折叠后体积小，实用性强，时尚美观。

Technical Specification:  
Size:32x22.5x5.5cm  
Materials:stainless steel body and  
PP handles  
Color:Silver  
Accessories:  
2 handles; 1 fork; 1 spatula;  
1 tong; 1 knife; 1 spoon;  
1 multifunctional knife;  
2 salt & pepper pots  
Packing: oxford carry bag  
Features: Easy carrying;  
Fashionable and cute.



## 18PCS BBQ TOOL SET 18件套铝柄烤具

### KG2729

产品信息：  
尺寸：50x48cm/50x24cm  
材料：不锈钢工具大身，铝手柄  
颜色：银色  
配件：1支铲；1支夹；1支叉；  
1支毛刷；8支玉米叉；6支烤针  
包装：铝盒  
特点：  
易清洁，折叠后体积小，  
实用性强，时尚美观高档

Technical Specification:  
Size: 50x48cm/50x24cm  
Materials: Stainless steel/Aluminum  
Color: Silver  
Accessories:1 multi-functional spatula;1 tong;  
1 fork;1 brush;8 corn cob forks;6 pins  
Packing: aluminum box  
Features:  
Easy carrying;  
Fashionable and durable.



## BBQ TOOL SET 烧烤工具

### KG2727

产品信息：  
尺寸：61x42cm  
材料：不锈钢  
颜色：银色  
配件：1支叉；1支铲；1支夹；1支铜刷；  
6支烤针；1个手套；1个围裙布袋  
包装：牛津布袋  
特点：  
易清洁，折叠后体积小，实用性强，时尚美观。

Technical Specification:  
Size: 61x42cm  
Materials: stainless steel and 600X300D oxford  
Color: Silver  
Accessories: 1 fork; 1 spatula; 1 tong;  
1 bronze brush;6 pins;1 cotton glove;1 apron  
Packing: oxford carry bag  
Features:  
Easy carrying;  
Fashionable and durable.



## 3PCS BBQ TOOL SET 烧烤工具三件套

### KG2728

产品信息：  
尺寸：47.5x7.5cm  
材料：不锈钢  
颜色：银色  
配件：1支铜刷；1支铲；1支夹；  
包装：牛津布袋  
特点：  
易清洁，折叠后体积小，  
实用性强，时尚美观。

Technical Specification:  
Size:61x42cm  
Materials:Stainless steel  
Color:Silver  
Accessories:1 bronze brush;1 spatula;1 tong;  
Packing: oxford carry bag  
Features:  
Easy carrying;  
Fashionable and durable.





**COOLER BOX**  
**20L保温箱**  
**KG3792**

产品信息：  
尺寸：20L  
材料：外层高密度聚乙烯HDPE，  
内层为聚苯乙烯食品级原料，  
中间保温层为聚氨酯PU  
颜色：绿色  
保温时间：48小时

Technical Specification:  
Size: 20L  
Materials: HDPE for shell,  
PS for inner,  
PU for thermal insulation material  
Color: Green  
Holding time: 48 hours



**COOLER BOX**  
**30L保温箱**  
**KG3793**

产品信息：  
尺寸：30L  
材料：外层高密度聚乙烯HDPE，  
内层为聚苯乙烯食品级原料，  
中间保温层为聚氨酯PU  
颜色：绿色  
保温时间：48小时

Technical Specification:  
Size: 30L  
Materials: HDPE for shell,  
PS for inner,  
PU for thermal insulation material  
Color: Green  
Holding time: 48 hours



**COOLER BOX**  
**43L保温箱**  
**KG3794**

产品信息：  
尺寸：43L  
材料：外层高密度聚乙烯HDPE，  
内层为聚苯乙烯食品级原料，  
中间保温层为聚氨酯PU  
颜色：绿色  
保温时间：48小时

Technical Specification:  
Size: 43L  
Materials: HDPE for shell,  
PS for inner,  
PU for thermal insulation material  
Color: Green  
Holding time: 48 hours



## DELUXE PADDED HAMMOCK

### 双层加棉吊床

**KG3765**

产品信息：

尺寸：360X140cm

材料：100%聚酯纤维

颜色：蓝色条纹

特点：夹棉，使用安全，舒适耐用  
易清洗，便于携带及存放

Technical Specification:

Size: 360X140cm

Fabric: 100% Polyester

Color: Blue Stripe

Feature: Safe for using

Durable and comfort

Easy cleaning and storage



## CANVAS NET HAMMOCK

### 棉绳网状吊床

**KG3766**

产品信息：

尺寸：330x140cm

材料：100% 棉

颜色：白色

特点：两端硬木支撑，  
使用安全，舒适耐用易清洗，  
便于携带及存放

Technical Specification:

Size: 330x140cm

Fabric: 100% cotton

Color: White

Feature: Safe for using

Durable and comfort

Easy cleaning and storage



## CANVAS HAMMOCK

### 双人帆布吊床

**KG3761**

产品信息：

尺寸：200X150cm

材料：65%棉35%涤纶

颜色：紫黄条纹/深蓝条纹

特点：涤棉材质比纯棉更结实，  
承重150Kg，色彩亮丽，  
面料耐磨，增强使用寿命，

Technical Specification:

Size: 200X150cm

Fabric: 65% Cotton 35% Polyester

Color: Purple yellow stripe/ dark blue stripe

Feature: Safe for using

Durable and comfort

Easy cleaning and storage



## CANVAS HAMMOCK

### 帆布吊床

#### KG3712

产品信息：  
 材料：硬杂木，100%棉布  
 颜色：蓝白条纹，红白条纹  
 特点：  
 100%纯棉，使用安全，舒适耐用；  
 易清洗，便于携带及存放

Technical Specification:  
 Size: 200x80cm  
 Color: Blue and white stripe-  
 Red and white stripe  
 Features:  
 100% cotton; Safe for using;  
 Durable and comfort,  
 Easy cleaning and storage.



## NET HAMMOCK

### 网状吊床

#### KG3713

产品信息：  
 尺寸：200x80cm  
 材料：硬杂木，尼龙绳  
 颜色：红黄蓝白拼色  
 特点：  
 使用安全，舒适耐用，  
 易清洗，便于携带及存放

Technical Specification:  
 Size: 200x80cm  
 Material: Nylon  
 Color: variedness  
 Features:  
 Nylon ropes; Safe for using;  
 Durable and comfort,  
 Easy cleaning and storage.



## CANVAS HAMMOCK

### 木棍帆布吊床

#### KG3762

产品信息：  
 尺寸：200X100cm  
 材料：65%棉35%涤纶  
 木棍：实木  
 特点：  
 涤棉材质比纯棉更结实，  
 承重100Kg，色彩亮丽，  
 面料耐磨，增强使用寿命

Technical Specification:  
 Size: 200X100cm  
 Fabric: 65% Cotton 35% Polyester  
 Feature:  
 Safe for using  
 Durable and comfort  
 Easy cleaning and storage





## CANVAS HAMMOCK

### 帆布吊床

#### KG3752

产品信息：

尺寸：200x100cm

面料：涤棉(65%棉35%涤)

颜色：彩条6种

特点：

涤棉材质比纯棉更结实，承重120Kg。  
颜色亮丽；附送2根2米绑绳，方便户外使用；  
两端织圈衬有铁圈，增强耐磨性，使用寿命更长。  
本布外袋，外袋配棉绳可搭在肩上方便携带，  
有吊钩方便店铺陈列展示。

Technical Specification:

Size: 2m x 1m

Fabric: 65% Cotton, 35% Polyester

Color: Colourful striped

Features:

Beautiful color, Iron ring on both ends,  
with better wear-resisting performance.

2 pcs 2m of rope along with the bed.

Carry bag for ease of transportation & storage.



## PARACHUTE HAMMOCK

### 降落伞布吊床

#### KG3753

产品信息：

尺寸：270x130cm

面料：210T尼龙起皱

承重：100kg

颜色：浅绿/墨绿，紫色/黄色，蓝色/青色

特点：

降落伞用尼龙布，结实的同时又非常轻薄，  
吊床一侧有连体收纳袋，展开可做临时储物袋，  
收后体积很小，便于携带。颜色亮丽。

Technical Specification:

Size: 270cm x 130m

Fabric: 210T nylon

Features:

Ultralight, Durable, Portable.

Bright color. Carry bag sewn together with  
the bed which can be used as a storage bag.





### KingCamp配件

配件主要是为旅行、徒步、露营等户外活动提供辅助性服务的产品。KingCamp配件按产品功能分为：炊具、餐具、照明、水具、防水、帐篷配件、登山、导航、工具等九大系列。

配件类产品的包装及陈列方式严格按照KingCamp产品标准统一规划，以满足不同渠道经销商终端销售陈列的需要：

- 1、全新系列的彩盒、彩卡包装，色调统一，配图鲜明，完美体现KingCamp家庭户外理念。
- 2、根据不同销售渠道产品陈列的特点，归纳总结了3种陈列货架：

A货架：适合30m<sup>2</sup> 商铺销售和陈列。

B货架：配合A货架适合50m<sup>2</sup> 商铺的销售和陈列。

C货架：适合80m<sup>2</sup> 商铺销售和陈列（此货架囊括了KingCamp绝大部分的配件类产品）

这样设计的目的是以后KingCamp配件产品销售将以货架为基本销售单位，从产品生产、包装、运输各个环节全程监控配件类产品的销售，减少运营成本，增加销售数量。

### KingCamp Accessories

KingCamp has a wide range of accessory products that assist all kinds of outdoor activities. The accessory range includes: Cookware, Dinnerware, Lighting, Water Carriers, Water-proofing, Tent Accessories and Mountaineering and Navigation accessories, Tools.

KingCamp assort accessories into three display styles to meet the needs of different markets and stores. By controlling the total process from production to packing and transportation, we can cut costs and increase sales. In addition, we can offer our distributors a better service and a convenient product selection process.

We have three kinds of accessory displays:

A for 30m<sup>2</sup> store

B for 50m<sup>2</sup> store

C for 80m<sup>2</sup> store

## CAMPER 2 露营四件套 KP3901

产品信息：  
材料：优质纯铝，耐磨、易清洗  
包含：铝锅2个  
尺寸：D17x8cm / D14cmx8cm  
煎盘1个，尺寸：D19x4cm  
手柄1个，织带1条  
产品特点：  
可堆叠，方便携带和存放。  
适合1 - 2人户外使用

Specification:  
Material: aluminium  
Including:  
2pcs pots: D17x8cm / D14cmx8cm  
1pc frying pan: D19x4cm  
1pc gripper  
1pc PP strap  
Features:  
Stackable, easy to carry and store.  
Ideal for 1-2 persons using.



## CAMPER 3 露营五件套 KP3902

产品信息：  
材料：优质纯铝，耐磨、易清洗  
包含：铝锅3个  
尺寸：D19.3x8cm / D17.8x8cm / D15x8cm  
煎盘1个，尺寸：D19.8x3.2cm  
手柄1个，织带1条  
产品特点：可堆叠，  
方便携带和存放。适合2 - 3人户外使用

Specification:  
Material: aluminium  
Including:  
3pcs pots: D19.3x8cm / D17.8x8cm / D15x8cm  
1pc frying pan: D19.8x3.2cm  
1pc gripper  
1pc PP strap  
Features:  
Stackable, easy to carry and store.  
Ideal for 2-3 persons using.



## CAMPER 4 露营六件套 KP3903

产品信息：  
材料：优质纯铝，耐磨、易清洗  
包含：铝锅3个  
尺寸：D20x10.5cm / D18x8cm / D17x8cm  
不粘煎盘1个，尺寸：D22x4cm  
水壶1个：1.5L, D14.5x12cm  
手柄1个  
产品特点：可堆叠，  
方便携带和存放。适合2 - 3人户外使用。

Specification:  
Material: aluminium  
Including:  
3pcs pots: D20x10.5cm / D18x8cm / D17x8cm  
1pc non-stick frying pan: D22x4cm  
1pc kettle: 1.5L, D14.5x12cm  
1pc gripper  
Feature:  
Stackable, easy to carry and store.  
Ideal for 2-3 persons using.





## DELUXE COOKSET I 豪华2 - 3人套锅

**KP4068**

产品信息：  
材料：优质铝，表面不沾涂层  
包含：铝锅2个  
尺寸：D20.5x8cm / D17.5x7cm  
煎盘2个，尺寸：D19x4cm / D16.5x4cm  
把手1个，织带1条，网袋1个  
产品特点：  
不粘涂层便于烹饪和清洁，  
底部平底，提高受热效率，  
堆叠后可装入外袋，方便携带和存放，  
适合2 - 3人户外使用。

Specification:  
Material: Aluminum with non-stick color coating  
Including:  
2pcs cooking pan: D20.5x8cm / D17.5x7cm  
2pcs frying pan: D19x4cm / D16.5x4cm  
1pc gripper, 1pc strap, 1pc mesh bag  
Feature:  
Ideal for 2-3 persons using.  
With non-stick coating, easy to clean.  
With flat bottom, to improve heat efficiency.  
Stackable, packed in mesh bag,  
easy to carry and store.



## CLIMBER II 三人硬质氧化套锅

**KP3911**

产品信息：  
材料：硬质氧化铝  
包含：带盖锅2个  
尺寸：D17x11cm / D15x9cm  
煎盘1个，尺寸：D18x4cm  
1个折叠汤勺  
1个塑料勺  
3个塑料碗  
1块百洁布  
1个手提袋  
产品特点：可折叠、轻便易携、  
易清洁，适合3 - 4人户外使用

Specification:  
Material: hard-anodized aluminium  
Including:  
2pcs pots with lid: D17x11cm / D15x9cm  
1 frying pan: D18x4cm  
1 foldable ladle  
1 melamine spoon  
3pcs melamine bowls  
1 cleaning sponge  
1 carry bag  
Feature:  
Foldable, easy to store and clean.  
Ideal for 3-4 persons using.



## CLIMBER III 五人硬质氧化套锅

**KP3912**

产品信息：  
材料：硬质氧化铝  
包含：带盖铝锅3个  
D19x14cm / D17x11cm / D15x9cm  
煎盘1个：D20x5cm  
1个折叠汤勺  
1个塑料勺，5个塑料碗  
2个碟子，1块百洁布  
1个手提袋  
产品特点：可折叠、轻便易携、  
易清洁，适合5-6人户外使用

Specification:  
Material: hard-anodized aluminium  
Including:  
3pcs pots with lid: D19x14cm / D17x11cm / D15x9cm  
1 frying pan: D20x5cm  
1 foldable ladle  
1 melamine spoon  
5pcs melamine bowls  
2pcs melamine plates  
1 cleaning sponge  
1 carry bag  
Feature:  
Foldable, easy to clean and store.  
Ideal for 5-6 person using.



### CLIMBER III 六人硬质氧化套锅 KP3913

产品信息：  
材料：硬质氧化铝  
包含：带盖铝锅3个  
D28X15.5cm / D24X13cm /  
D20X10.5cm  
厚度：1.0mm；  
1个手提袋  
产品特点：  
可堆叠、轻便易携、易清洁，  
适合6-8人户外使用

Specification:  
Material: hard-anodized aluminium  
Including: 3pcs pots:  
D28X15.5cm/D24X13cm/  
D20X10.5cm  
Thickness: 1.0mm;  
1 carry bag  
Feature:  
Stable, easy to clean and store.  
Ideal for 6-8 persons using.



### BACKPACKER III 二人不锈钢套锅 KP3914

产品信息：  
材料：不锈钢  
包含：带盖锅1个：D16x7.5cm  
煎盘1个：D15.6x3.5cm  
2个盘子：D14.5x2cm  
2个碗：D9.6x4.5cm  
1个手提袋  
产品特点：  
可折叠、轻便易携、  
易清洁，适合2人户外使用

Specification:  
Material: stainless steel  
Including:  
1 pot with lid: D16x7.5cm  
1 frying pan: D15.6x3.5cm  
2pcs plates: D14.5x2cm  
2pcs bowls: D9.6x4.5cm  
1 carry bag  
Feature: Foldable,  
easy to store and clean.  
Ideal for 2 person using.



### BACKPACKER III 四人不锈钢套锅 KP3915

产品信息：  
材料：不锈钢  
包含：带盖锅3个：  
D20.7x9.5cm / D18.4x8cm / D17x8cm  
煎盘2个：D21.5x4cm / D18x3.5cm  
水壶1个：容量1L, D14.5x9cm  
1个手提袋，1个锅夹  
产品特点：  
可折叠、轻便易携、  
易清洁，适合4人户外使用

Specification:  
Material: stainless steel  
Including: 3pcs pots with lid:  
D20.7x9.5cm / D18.4x8cm / D17x8cm  
2pcs frying pans: D21.5x4cm / D18x3.5cm  
1 kettle: capacity 1L, D14.5x9cm  
1 gripper  
1 carry bag  
Feature: Foldable,  
easy to store and clean.  
Ideal for 4 persons using.



## MESS KIT 刀叉勺三件套

### KA3636

产品信息：  
材料：耐久不锈钢  
尺寸：175mm  
包含：刀、叉、勺  
产品特点：理想的户外野营工具，  
自锁系统便于安装成一套，轻巧便携。

Specification:  
Material: stainless steel  
Size: 175mm  
Including: knife, fork and spoon  
Feature:  
Ideal for outdoor camping.  
Inner locking system, set in one,  
easy to carry and store.



## MULTIFUNCTION MESS KIT 露营工具3件套

### KA3643

产品信息：  
材料：耐久不锈钢  
包含：刀、叉、勺和尼龙套  
产品特点：理想的户外野营工具，  
自锁系统便于安装成一套，  
装入尼龙袋，轻巧便携

Specification:  
Material: stainless steel  
Including: knife, fork, spoon and nylon sheath  
Feature:  
Ideal for outdoor camping use.  
Inner locking system.  
Packed in one nylon sheath,  
easy to carry and store.



## CHOW KIT SET 刀叉勺三件套

### KA2996

产品信息：  
材料：耐久不锈钢  
包含：刀、叉、勺、不锈钢管套  
产品特点：  
理想的户外野营工具，  
自锁系统便于安装成一套，轻巧便携。

Specification:  
Material: stainless steel  
Including: knife, fork, spoon and sheath  
Feature:  
Ideal for outdoor camping use.  
Inner locking clip system.  
Packed in one sheath,  
easy to carry and store.



## FOLDABLE CHOPSTICKS 折叠筷子

### KA2998

产品信息：  
材料：红檀木  
尺寸：展开：7.2x210mm  
折叠：7.2x110mm  
包含：筷子、外袋  
产品特点：理想的户外野营工具，  
折叠后装入外袋，轻巧便携。

Specification:  
Material: sanders  
Size: Stretch: 7.2x210mm  
Fold: 7.2x110,mm  
Including: chopsticks, sheath  
Feature: Packed in one sheath,  
easy to carry and store.  
Ideal for outdoor picnic use.



## WOOD MESS KIT 木制餐具套装

### KA2999

产品信息：  
材料：檀木  
尺寸：筷子：7.5X200mm  
勺子：40X200mm  
包含：筷子、勺子、外袋  
产品特点：理想的户外野营工具，  
可装入外袋，轻巧便携。

Specification:  
Material: sanders  
Size: chopsticks: 7.5X200mm  
spoon: 40X200mm  
Including: chopsticks, spoon and sheath  
Feature: Ideal for outdoor picnic use.  
Packed in one sheath, easy to carry and store.



## WOOD KIT SET 木制餐具套装

### KA3000

产品信息：  
材料：不锈钢，檀木  
尺寸：筷子：200x6.5mm  
勺子：140x30mm  
叉子：140x20mm  
产品特点：理想的户外野营工具，  
可装入外袋，轻巧便携。

Specification:  
Material: stainless steel, sanders  
Size: Chopsticks: 200x6.5mm  
Spoon: 140x30mm  
Fork: 140x20mm  
Feature: Ideal for outdoor picnic use.  
Packed in one sheath,  
easy to carry and store.





## FOLDABLE MUG I

### 折叠酒杯

#### KA3002

产品信息：  
材料：不锈钢  
展开尺寸：5.5×5.5×6cm  
容量：60ml  
产品特点：  
理想的户外野餐工具，  
可折叠，轻巧便携。

Specification:  
Material: stainless steel  
Size: 5.5×5.5×6cm  
Capacity: 60ml  
Feature: Foldable,  
easy to carry and store.  
Ideal for outdoor picnic use.



## FOLDABLE MUG II

### 折叠酒杯

#### KA3003

产品信息：  
材料：不锈钢  
展开尺寸：6.5×6.5×7cm  
容量：150ml  
产品特点：  
理想的户外野餐工具，  
可折叠，轻巧便携。

Specification:  
Material: stainless steel  
Size: 6.5 × 6.5 × 7 cm  
Capacity: 150ml  
Feature: Foldable,  
easy to carry and store.  
Ideal for outdoor picnic use.



## 1 OZ ROUND CENTER KEYCHAIN HIP FLASK 30ML

### 急救酒壶

#### KA8118

产品信息：  
材料：不锈钢  
尺寸：4.5×2.2×7.8cm  
容量：30ml  
特点：镜面抛光，防尘防酸。  
急救酒壶，适合徒步户外使用。

Specification:  
Material: Stainless steel  
Size: 4.5×2.2×7.8cm  
Capacity: 30ml  
Feature: 18/8 Grade High Quality Stainless Steel,  
100% brand new, safe and healthy.  
Fits in the palm of your hand, slips into your pocket or purse.  
Keychain clip easily attaches to your backpack or belt loop.  
It holds 1 ounce for emergency.



## HIP FLASK II

### 不锈钢酒壶

#### KA3005

产品信息：  
材料：不锈钢  
尺寸：8.5×2.5×13cm  
容量：170ml  
产品特点：  
表面砂光处理

Specification:  
Material: stainless steel  
Size: 8.5×2.5×13cm  
Capacity: 170ml  
Feature:  
Surface sanding burnished.  
Arc welding, without closed angle.  
Easy to carry and store.  
Ideal for outdoor picnic use.



## 6 OZ CLASSIC HIP FLASK 170ML

### 酒壶

#### KA8110

产品信息：  
材料：不锈钢  
尺寸：9.7×2.2×11cm  
容量：170ml  
特点：18/8食品级不锈钢，镜面抛光，  
防尘防酸。顶盖不会脱落，  
防止壶盖丢失，适合单人户外使用。

Specification:  
Material: Stainless steel  
Size: 9.7 × 2.2 × 11cm  
Capacity: 170ml  
Feature: 18/8 Grade High Quality Stainless Steel,  
100% brand new, safe and healthy.  
It holds 6 ounces of your favorite beverage.  
It has a Captive top included with High Polish.



## 4 OZ JERRY CAN HIP FLASK 110ML

### 酒壶

#### KA8114

产品信息：  
材料：不锈钢  
尺寸：7.2×3.2×9.8cm  
容量：110ml  
特点：18/8食品级不锈钢，  
镜面抛光，防尘防酸。  
带拎手设计。  
适合单人户外使用。

Specification:  
Material: Stainless steel  
Size: 7.2×3.2×9.8cm  
Capacity: 110ml  
Feature: 18/8 Grade High Quality Stainless Steel,  
100% brand new, safe and healthy.  
It holds 4 ounces of your favorite beverage.  
It has a handle for easy using.



## 9 OZ FLASK SET 250ML

## 酒壶礼品套装

## KA8123

产品信息：

材料：不锈钢

酒壶尺寸：9.7×2.5×14.5cm

酒杯尺寸：3.9×3.9×3.9cm

漏斗尺寸：3.5×3.5×3cm

酒壶容量：250ml

特点：一壶四杯一漏斗。

18/8食品级不锈钢，镜面抛光，

防尘防酸。做工精致，

适合家庭 / 好友小酌，

或作为赠友礼品。

Specification:

Material: Stainless steel

Capacity: 250ml

Feature:

6 Piece Classical Gift Set.

Made of 18/8 Grade

High Quality Stainless Steel.

1pc Large Flask holds 9oz.

4pc Shot Glasses and 1pc easy pour funnel.

Value set, good for many occasions and a great

Holiday Gift!



## STAINLESS STEEL MUG

## 不锈钢杯子

## KA3675

产品信息：

材料：不锈钢

容积：250ml

产品特点：

登山扣把手，可折叠，方便携带，理想的室内及户外野营用品。

Specification:

Material: stainless steel

Volume: 250ml

Feature:

Carabiner handle,

foldable, easy to carry.

Ideal for both indoor and outdoor camping use.



## TRAY

## 圆盘餐具

## KA3007

产品信息：

材料：不锈钢

尺寸：17.3×2.5cm

产品特点：

结实耐用，轻巧便携，理想的户外野营工具。

Specification:

Material: stainless steel

Size: 17.3×2.5cm

Feature:

Sturdy, easy to carry and store.

Ideal for outdoor picnic use.



## BOWEL

## 折叠碗

## KA3006

产品信息：

材料：不锈钢

尺寸：14×10.1×5.1cm

产品特点：

可折叠，轻巧便携，理想的户外野营工具。

Specification:

Material: stainless steel

Size: 14×10.1×5.1cm

Feature:

Sturdy, easy to carry and store.

Ideal for outdoor picnic use.



## TRAY

## 浅口盘

## KA3008

产品信息：

材料：不锈钢

尺寸：18.3×2cm

产品特点：

结实耐用，轻巧便携，理想的户外野营工具。

Specification:

Material: stainless steel

Size: 18.3×2cm

Feature:

Sturdy, easy to carry and store.

Ideal for outdoor picnic use.



## SILICONE FOLDABLE CUP WITH LID 250ML

### 小号硅胶杯250ML

#### KA6301

产品信息：  
 材质：食品级硅胶  
 展开尺寸：D5.7/9.5×7.5cm  
 折叠尺寸：D5.7/9.5×4cm  
 容量：250ML  
 产品特点：不含 BPA，安全实用，  
 折叠体积小，方便携带。  
 适用 -40° C—230° C，  
 适用于野营和旅行。

Specification:  
 Material: Food grade silicone  
 Stretched size: D5.7/9.5×7.5cm  
 Folded size: D5.7/9.5×4cm  
 Capacity: 250ML  
 Features: BPA free,  
 environmental, foldable.  
 Temperature range: -40° C—230° C  
 Ideal for camping, picnic, travelling.



## SILICONE FOLDABLE CUP WITH LID 540ML

### 硅胶碗540ML

#### KA6302

产品信息：  
 材质：食品级硅胶  
 展开尺寸：D9.7/13.5×8cm  
 折叠尺寸：D9.7/13.5×4.5cm  
 容量：540ML  
 产品特点：不含 BPA，安全实用，  
 折叠体积小，方便携带。  
 适用 -40° C—230° C，适用于野营和旅行。

Specification:  
 Material: Food grade silicone  
 Stretched size: D9.7/13.5×8cm  
 Folded size: D9.7/13.5×4.5cm  
 Capacity: 540ML  
 Features: BPA free,  
 environmental, foldable.  
 Temperature range: -40° C—230° C  
 Ideal for camping, picnic, travelling.



## SILICONE FOLDABLE LUNCH BOX 1.1L

### 单盒饭盒 1.1L

#### KA6524

产品信息：  
 材质：食品级硅胶  
 展开尺寸：20x13x8cm  
 折叠尺寸：20x13x5cm  
 容量：1.1L  
 产品特点：不含 BPA，安全实用，  
 折叠体积小，方便携带。  
 适用 -40° C—230° C，适用于野营和旅行。

Specification:  
 Material: Food grade silicone  
 Stretched size: 20x13x8cm  
 Folded size: 20x13x5cm  
 Capacity: 1.1L  
 Features: BPA free,  
 environmental, foldable.  
 Temperature range: -40° C—230° C  
 Ideal for camping, picnic, travelling.



## SILICONE FOLDABLE LUNCH BOX 1.6L

### 双盒饭盒 1.6L

#### KA6525

产品信息：  
 材质：食品级硅胶  
 展开尺寸：26x19x7cm  
 折叠尺寸：26x19x4cm  
 容量：1600ML  
 产品特点：不含 BPA，  
 安全实用，折叠体积小，方便携带。  
 适用 -40° C—230° C，适用于野营和旅行。

Specification:  
 Material: Food grade silicone  
 Stretched size: 26x19x7cm  
 Folded size: 26x19x4cm  
 Capacity: 1.6L  
 Features: BPA free, environmental, foldable.  
 Temperature range: -40° C—230° C  
 Ideal for camping, picnic, travelling.



## SILICONE FOLDABLE BUCKET 7.3L

### 折叠硅胶水桶 7.3L

#### KA6309

产品信息：  
 材质：食品级硅胶  
 展开尺寸：D15/28x20.3cm  
 折叠尺寸：D28x4.5cm  
 容量：7.3L  
 产品特点：不含 BPA，  
 安全实用，折叠体积小，方便携带。  
 适用 -40° C—230° C，适用于野营、钓鱼、野餐。

Specification:  
 Material: Food grade silicone  
 Stretched size: D15/28x20.3cm  
 Folded size: D28x4.5cm  
 Capacity: 7.3L  
 Features: BPA free, environmental, foldable.  
 Temperature range: -40° C—230° C  
 Ideal for camping, fishing, picnic.



## SILICONE AIR TRAVEL BOTTLE 60ML

### 旅行乳液携带瓶 60ML

#### KA6530

产品信息：  
 材质：食品级硅胶  
 尺寸：D3.5x11cm  
 容量：60ML  
 产品特点：不含 BPA，用于分装洗发液、  
 沐浴露、防晒霜、洗面奶、擦脸油等；  
 安全实用，方便携带。  
 适用 -40° C—230° C，适用于旅行、露营等。

Specification:  
 Material: Food grade silicone  
 Size: D3.5x11cm, Weight: 52g  
 Capacity: 60ML  
 Features: BPA free, Squeezable with Shampoo/  
 Cond./Sun/Lotion/Soap indication. Special  
 non-drip valve to keep the cap clean.  
 Wide opening for easy filling and cleaning.  
 Temperature range: -40° C—230° C  
 Ideal for camping, travelling.





## MINI POWERFUL CAMPING LIGHT 迷你高亮度营地灯

### KA2313

产品描述：  
 材质：ABS + PP  
 灯泡：2x5730 0.5W  
 流明：100流明（最大）  
 防水等级：IPX4  
 产品尺寸：72x72x45mm  
 产品重量：54 g(不含电池)  
 电池：3 x AA（不含）  
 产品特点：  
 照明模式：开/关，  
 正面中心位置感应开关  
 （轻轻长按开关2秒钟打开/关闭灯泡）  
 尺寸小，亮度高  
 折叠拎手，方便携带

Specification:  
 Material: ABS + PP  
 Bulb: 2 x 5730 LEDs  
 Max output: 100 lumens  
 Water Proof: IPX4  
 Product Size: 72x72x45mm  
 Product Weight: 54 g (not include battery)  
 Battery: 3 x AA (not include)  
 Features:  
 Lighting mode: on / off  
 (press the switch lightly for 2 seconds to turn on / off the LEDs)  
 Mini size, high brightness.  
 Foldable handle, easy to carry and store.



## 5W CREE CAMPING LIGHT - S 5W CREE小号营地灯

### KA2327

产品信息：  
 材质：ABS+PC+TPR+铁丝  
 灯泡：1颗5W CREE 灯泡  
 流明：100流明（最大）  
 产品尺寸：Dia.95 x 185 mm  
 产品重量：291 g (不含电池)  
 电池：4 x AA（不含）  
 产品特点：  
 照明模式：开/关 逐光  
 （不停地旋转开关调节灯光明暗程度）  
 CREE 灯泡，大品牌，高品质  
 折叠拎手，方便携带  
 可悬挂，理想的户外野营用品

Specification:  
 Material: ABS+PC+TPR+STEEL  
 Bulb: 1 x 5W CREE LED  
 Lumen: 100 lumens (max)  
 Product Size: Dia.95 x 185 mm  
 Product Weight: 291 g (not include battery)  
 Battery: 4 x AA (not include)  
 Features:  
 Lighting mode: on / off dimmer  
 CREE LED, famous brand, high quality  
 With Foldable handle,  
 easy to carry and store,  
 ideal for outdoor camping use.



## 5W CREE CAMPING LIGHT - L 5W CREE大号营地灯

### KA2329

产品描述：  
 材质：ABS+PC+TPR+铁丝  
 灯泡：1颗5W CREE 灯泡  
 流明：220流明（最大）  
 产品尺寸：Dia.130 x 250 mm  
 产品重量：499 g (不含电池)  
 电池：4 x D（不含）  
 产品特点：  
 照明模式：开/关 逐光（不停地旋转开关调节灯光明暗程度）  
 CREE 灯泡，大品牌，高品质  
 折叠拎手，方便携带  
 可悬挂，理想的户外野营用品

Specification:  
 Material: ABS+PC+TPR+STEEL  
 Bulb: 1 x 5W CREE LED  
 Lumen: 220 lumens (max)  
 Product Size: Dia.130 x 250 mm  
 Product Weight: 499 g (not include battery)  
 Battery: 4 x D (not include)  
 Features:  
 Lighting mode: on / off dimmer  
 CREE LED, famous brand, high quality  
 With Foldable handle,  
 easy to carry and store,  
 ideal for outdoor camping use.



## 4 IN 1 RECHARGEABLE SPOTLIGHT CAMPING LANTERN 四合一手摇充电手电

### KA1306

产品描述：  
材质：ABS+PC  
LED：闪光灯3粒，营地灯10粒，5粒红光  
产品尺寸：D9.7x18.6 cm  
产品重量：约320g  
电池：锂电池 360mAh, 3.7V (包含)  
产品特点：照明模式：闪光--营地灯--红光--关闭  
输出电压：5.5±0.2V  
外接电源充电时间：6小时可充满  
手摇充电时间：70分钟可充满  
可手摇给手机、数码产品充电，可手摇

Specification:  
Material: ABS+PC  
LED: High brightness 3 LEDs for spotlight  
10 straw-hat lights and 5 red flash lights for camping lantern  
Product size: D9.7x18.6 cm  
Product weight: 320g (approx.)  
Nimh Battery: 300 mah 3.6 V (included)  
Features:Lighting mode: Spotlight→ Lantern →Red Flash→ off,  
Output voltage: 5.5±0.2V fully charging time by outer source power:  
approx 6 h.fully charging time by cranking: 70 min  
Cranking for power to charge mobile phone or digital products.  
Dynamo, USB port by computer power, DC IN by outer sources.



## 3 IN 1 EMERGENCY AUTO SAFETY TOOL 三合一安全工具

### KA1307

产品信息：  
材质：ABS  
LED：3粒  
产品尺寸：12.2x5.2x5.9 cm  
产品重量：约118 g  
电池：锂电池 80 mAh 3.6V (包含)  
产品特点：照明模式：闪光--营地灯--关闭  
输出电压：5.5±0.2V  
续航时间：闪光2小时，照明80分钟  
产品配有玻璃锤及安全带割刀，可用于车载

Specification:  
Material: ABS  
LED: 3 LEDs  
Product size: 12.2x5.2x5.9 cm  
Product weight: 118 g (approx.)  
Nimh Battery: 80 mAh 3.6V NI-MH (included)  
Features:Lighting mode: Flashing-- Lighting --off  
Output voltage: 5.5±0.2V  
Lighting time: approx 2h.(flashing), 80 minutes(lightning)  
Life-saving impactive needle:  
Take off the protective cover, then stress the hammer head onto the glass until the distance is less than 0.5mm, so as to smash the window.



## MINI TELESCOPIC CAMPING TORCH MINI可伸缩营地灯

### KA1308

产品描述：  
材质：ABS  
LED：3粒  
产品尺寸：D8.43x5 cm  
产品重量：约168g  
电池：锂电池 :300mAh, 3.7V (包含)  
产品特点：  
照明模式：弱光--强光--关闭  
输出电压：5.5V  
外接电源充电时间：4小时可充满  
手摇充电时间：35分钟可充满  
可手摇、USB接口、插充

Specification:  
Material: ABS  
LED: 3 LEDs  
Product size: D8.43x5 cm  
Product weight: 168 g (approx.)  
Nimh Battery:300mAh, 3.7V polymer lithium battery (included)  
Features:Lighting mode:Low level lighting of 0.5W LED--high level lighting of 0.5W LED-- off  
Output voltage: 5.5V  
Fully charging time by outer source power: approx 4 h.  
Fully charging time by cranking: 35 min  
Smart protection chip: over-charging protection, over-discharge protection, short circuit protection.Torch or Lantern.  
Dynamo, USB port by computer power, DC IN by outer sources.



## DETACHABLE CAMPING LIGHT 可拆分营地灯

### KA4921A

产品信息：  
材质：ABS  
LED：70粒  
产品尺寸：D13x26cm  
主灯电池：3.7V/4000mAh (包含)  
手电筒电池：3 x "AAA" (不含)  
产品特点：  
照明模式：低档15LED亮，高档60LED亮。拎手可折叠，也可打开用于悬挂，理想的户外野营用品

Specification:  
Material: ABS  
LED: 70pcs  
Product size: D13x26cm  
Battery for main light: 3.7V/4000mAh (included)  
Battery for torch: 3 x "AAA" (not included)  
Features:Lighting mode: low 15LEDs--high 60LEDs  
Foldable hanging hook,  
ideal for outdoor camping use.



## 4LED CAMPING LIGHT

## 4LED营地灯

## KA4928

产品信息：  
 产品材质：ABS+PC  
 LED：4粒  
 尺寸：D6.5 X 15cm  
 电池：3 X "AAA" (不含)  
 产品特点：  
 带拎手，小巧，便携

Specification:  
 Material: ABS  
 LED: 4pcs  
 Size: D6.5 X 15cm  
 Battery: 3 X "AAA" (not included)  
 Feature:  
 With handle,  
 mini size, simple design.



## 5 LED CAMPING LIGHT

## 5LED营地灯

## KA4931

产品信息：  
 产品材质：ABS  
 LED：5粒  
 尺寸：D5X 14cm  
 电池：4 X "AA" (不含)  
 产品特点：  
 照明模式：强光，弱光，闪烁  
 带挂钩，小巧便携

Specification:  
 Material: ABS  
 LED: 5pcs  
 Size: D5X 14cm  
 Battery: 4 X "AA" (not included)  
 Feature:  
 Lighting mode: high, low, flash  
 With hanging hook,  
 mini size, simple design.



## 8 LED CAMP LAMP 8LED

## 营地灯

## KA3704

产品信息：  
 材质：ABS  
 LED：8粒  
 产品尺寸：D9.6x18.2cm  
 电池：4x "c" (不含)  
 产品特点：  
 经久耐用可折叠手柄  
 产品顶部带有指南针  
 理想的户外野营用品

Specification:  
 Material: ABS  
 LED: 8pcs  
 Product size: D9.6x18.2cm  
 Battery: 4x "c" (not included)  
 Features:  
 Durable folding carry handle.  
 Foldable hanging hook.  
 With a compass on the top,  
 ideal for outdoor camping use.



## 9 LED CAMP LAMP

## 9 LED野营灯

## KA3706

产品信息：  
 材质：ABS  
 LED：9粒  
 产品尺寸：D6X16cm  
 电池：4x "AA" (不含)  
 产品特点：  
 经久耐用手柄绳，底部带挂环，  
 可倒挂。

Specification:  
 Material: ABS  
 LED: 9pcs  
 Product size: D6X16cm  
 Battery: 4x "AA" (not included)  
 Features:  
 Durable carry corp.  
 Foldable hanging hook, easy to carry and stock.  
 Can be used as a flashlight.  
 Ideal for outdoor camping use.





## 19LED RAINPROOF LIGHT 19LED防雨灯

### KA3101

产品信息：  
材质：ABS  
LED：19粒  
尺寸：D9.8x4cm  
产品特点：照明模式：低亮度，高亮度，  
红灯照明，红灯闪烁，手摇充电，  
外用USB接口5 V电源充电，  
可吸附在铁制品上，  
带拎手和挂钩，防水功能

Specification:  
Material: ABS  
LED: 19PCS  
Size:D9.8x4cm  
Features:  
Lighting models: 16 white LED  
low-brightness, 16 white LED high-brightness,  
3 red LED lighting, 3 red LED SOS flashing  
Cranking for power generation,  
or use external 5 V charge via USB port.  
Sticking to iron object.Hanging hook,rainproof.



## MINI DYNAMO TORCH 迷你手摇手电

### KA4252

产品信息：  
材质：ABS  
LED：3粒  
尺寸：8.1x4.9x3.8cm  
产品特点：  
照明模式：1LED, 3LEDs，  
闪烁求救  
手摇充电  
小巧，便携

Specification:  
Material: ABS  
Size: 8.1x4.9x3.8cm  
LED: 3pcs  
Feature:  
Lighting mode: 1LED, 3LEDs, flashing  
Crank to charge the built-in  
rechargeable battery.  
Brightness adjustable,  
flash for warning.Mini size,  
easy to carry and store.



## 27 LED WORK LIGHT 27 LED 工作灯

### KA4257

产品信息：  
材质：ABS  
LED：27粒  
尺寸：9.5 x 6 x 3.5 cm  
产品特点：  
照明模式：24LEDs, 3LEDs  
亮度可调节，  
小巧便携，  
带有磁铁，可吸附在其他物品上。

Specification:  
Material: ABS  
Size: 9.5 x 6 x 3.5 cm  
LED:27pcs  
Lighting mode: 24LEDs, 3LEDs  
Features:  
Brightness adjustable.  
Mini size, easy to carry and store.  
With magnet, can be stick to fixture.



## 5 LED HEADLAMP 五粒LED头灯

### KA3666

产品信息：  
材质：ABS  
LED：5粒  
尺寸：62×40×38mm  
产品特点：  
照明模式：1LED, 5LED闪, 5LED  
续航时间：40小时  
亮度可调节,小巧便携,带有磁铁，  
可吸附在其他物品上。

Specification:  
Material: ABS  
Size: 62×40×38mm  
Product weight: 38g (without package),  
54g (with package)  
Features:  
Lighting mode: 1 LED flashing,  
5LED flashing,5LED.OFF  
Burning time: 40 h  
Mini size, easy to carry and store.  
With magnet, can be stick to fixture.



## DOUBLE ACTION PUMP 双向手拉气泵

### KA3633

产品信息：  
材料：PP和ABS  
容积：2X1400CC  
产品特点：3款气嘴，适用于大部分阀口，  
轻松充气 and 放气，理想的气床、  
气垫等产品的充气工具。

Specification:  
Material: PP,ABS  
Volume: 2X1400CC  
Feature: 3 nozzles,  
to meet major style of valves.  
Easy to inflate and deflate.  
Ideal for airbed,  
air mattress and other inflatables.



## FOOT PUMP 3L 脚踏气泵 3L KA3659 FOOT PUMP 5L 脚踏气泵 5L KA3759 FOOT PUMP 6L 脚踏气泵 6L KA3760

产品信息：  
材料：PP, EVA  
容积：3L/ 5L/ 6L  
产品特点：3款气嘴，适用于大部分阀口，  
轻松充气 and 放气，理想的气床、  
气垫等产品的充气工具。

Specification:  
Material: PP, EVA  
Volume: 3L/ 5L/ 6L  
Feature: 3 nozzles,  
to meet major style of valves.  
Easy to inflate and deflate.  
Ideal for airbed,  
air mattress and other inflatables.



## ELECTRIC PUMP 电动气泵

### KA3644B

产品信息：  
材料：ABS塑料  
输入电压：交流电110-230V 直流电12V  
产品特点：3款气嘴，  
适用于大部分阀口轻松快速充气，  
理想的气床、气垫、  
气船等产品的充气工具

Specification:  
Material: ABS  
Input: AC110-230V, DC 12V  
Feature: 3 nozzles, to meet most valves  
Inflate easy and fast, Ideal for airbed,  
air mattress and other inflatables.



## FOLDABLE RACK 折叠支架

### KA1103

产品信息：  
材料：铝合金  
收纳包装尺寸：45×6×5 cm  
组装后支架长度：120 cm  
管径：1.2 cm  
产品特点：  
户外实用型野餐支架，  
适合团队及家庭露营，野餐，  
篝火使用，免拆装伸缩设计，  
挂链可调节烧烤高度，轻便易携。

Specification:  
Material: aluminium  
Package Size: 45×6×5 cm  
Overall length: 120cm  
Shaft: 1.2cm  
Feature:  
Functional outdoor picnic rack,  
ideal for team or family camping, picnic, and campfire.  
Foldable, adjustable, easy to carry and store.



## TRI-FOLDED SHOVEL 三折带镐折叠铲

### KA3105

产品信息：  
材料：钢  
铲头宽度：9cm  
长度：展开：41x9cm  
折叠：15.5x9cm  
产品特点：  
带锯齿和镐，可折叠，  
装于尼龙袋，便于携带。

Specification:  
Material: Stain Steel  
Blade Width: 9cm  
Length: Stretch: 41x9cm  
Foldable Size: 15.5x9cm  
Feature:  
With saw, pickax, foldable,  
packed in nylon pouch,  
easy to carry and store.



## TRI-FOLD SHOVEL

### 三折铲

#### KA6806

产品信息：  
 材料：钢  
 铲头尺寸：20.5x15cm  
 长度：24/58cm  
 产品特点：  
 带锯齿和镐，可折叠，  
 装于尼龙袋，便于携带

Specification:  
 Material: Steel  
 Blade size: 20.5X15cm  
 Length: 24/58cm  
 Feature: With saw,  
 pickax, Foldable,  
 packed in nylon pouch,  
 easy to carry and store.



## THUNDER 雷神

#### KA6809

产品信息：  
 材质：不锈钢，铝合金  
 产品尺寸：打开：72.5cm，折叠：57.5cm  
 单品包装尺寸：62.4x23.4x7.2cm  
 多功能兵工铲：铲子、锄头、刀、锯、叉、锥、  
 户外生存工具，手柄可延长

Specification:  
 Material: Stainless steel, Aluminum  
 Unfold size: 72.5cm  
 Fold size: 57.5cm  
 Package Size: 62.4x23.4x7.2cm  
 Multi-function shovel: Shovel, Hoe,  
 Knife, Saw, Awl, Outdoor survival tools,  
 Extractable handle  
 Ideal for camping and home life.



## KA6808 SMART 风雷

#### KA6808

产品信息：  
 材质：不锈钢，铝合金  
 产品尺寸：打开：56cm，  
 铲头：44cm，  
 折叠：24cm

单品包装尺寸：33x22x7cm  
 多功能兵工铲：铲子、锄头、刀、锯、强光手电  
 手电照明模式：强光（180流明）→中光（150流明）  
 →弱光（100流明）→频闪→SOS闪烁  
 手电自带18650锂电池，送充电器。

Specification:  
 Material: Stainless steel, Aluminum  
 Unfold size: 56cm  
 Fold size: 24cm  
 Package Size: 33x22x7cm  
 Multi-function shovel: Shovels, Hoes, Knives, Saws, Flashlight  
 Lighting mode: high brightness (180 lumens)→  
 mid brightness (150 lumens)→low brightness  
 (100 lumens)→flashing light→SOS flashing  
 Battery: 18650, with charger  
 Ideal for camping and home life.



## SHIELD

### 神盾

#### KA6810

产品信息：  
 材质：不锈钢，铝合金  
 产品尺寸：84.5cm（组装后）  
 单品包装尺寸：35x31.5x9.2cm  
 多功能兵工铲：铲子、锄头、刀、  
 锯、强光手电、钩、锥、叉、钳、  
 开瓶器、户外生存工具，手柄可通用  
 手电照明模式：  
 强光（180流明）→中光（150流明）  
 →弱光（100流明）→频闪→SOS闪烁  
 手电自带18650锂电池，送充电器

Technical Specification:  
 Material: Stainless steel, Aluminum  
 Unfold size: 84.5cm  
 Package Size: 35x31.5x9.2cm  
 Multi-function shovel: Shovel, Hoe, Knife,  
 Saw, Flashlight, Hook, Awl, Fork, Pliers,  
 Bottle opener, Outdoor survival tools  
 Lighting mode: high brightness (180 lumens)→  
 mid brightness (150 lumens)→  
 low brightness (100 lumens)→  
 flashing light→SOS flashing  
 Battery: 18650, with charger  
 Ideal for camping and home life.





## SOLAR SHOWER 20L

### 太阳能淋浴器

**KA3658**

产品信息：  
 材料：无毒PVC（聚氯乙烯）  
 容量：20L  
 产品特点：  
 轻便易携，太阳能加热，  
 适合户外使用。

Specification:  
 Material: Non-toxic PVC  
 Capacity: 20L  
 Feature:  
 Solar heated, light weight,  
 compact and easy to use.



## SOLAR SHOWER 20L

### 太阳能淋浴器

**KA4288**

产品信息：  
 材料：无毒PVC（聚氯乙烯）  
 容量：20L  
 产品特点：太阳能加热，  
 温度显示，用前查看，  
 以免烫伤。魔术贴加固，  
 使用更安全，储物袋，  
 存放洗漱用品，网袋包装，轻便易携。

Specification:  
 Material: Non-toxic PVC  
 Capacity: 20L  
 Feature:  
 Solar heated, temperature label,  
 read it before get burnt.  
 Velcro on both sides to fix the bag.  
 Mesh pocket in front for holding washing necessities.  
 Pack in mesh bag, easy to carry and store.



## PONCHO

### 涤纶雨衣

**KA2816**

产品信息：  
 材料：涤纶  
 尺寸：135×175 cm  
 特点：防水，穿着舒适，  
 可多次使用，可覆盖背包。

Technical Specification:  
 Material: Polyester  
 Size: 135×175 cm  
 Feature:  
 High waterproof,  
 reusable, lightweight.  
 Drawstring-adjustable,  
 full-coverage hood.



## PVC PONCHO

### PVC雨衣

**KA2711**

产品信息：  
 材料：聚乙烯  
 尺寸：127×203cm  
 产品特点：  
 可多次使用，可覆盖背包，  
 适合所有人的尺寸。

Specification:  
 Material: polyethylene  
 Size: 127×203cm  
 Feature:  
 Reusable,  
 backpack coverable,  
 one size fits all.



CAMPER TOWEL S 绒面快干毛巾 **KA3648**  
 CAMPER TOWEL M 绒面快干毛巾 **KA3711**  
 CAMPER TOWEL L 绒面快干毛巾 **KA4216**  
 CAMPER TOWEL XL 绒面快干毛巾 **KA4217**

产品信息：  
 材料：85%涤纶，15%锦纶  
 尺寸：30X60cm ( KA3648 )  
 45X90cm ( KA3711 )  
 60X120cm ( KA4216 )  
 90X180cm ( KA4217 )  
 包装：提袋  
 产品特点：  
 毛圈工艺，柔软，吸湿，速干。

Specification:  
 Material: 85%polyester, 15%polyamide  
 Size: 30X60cm(KA3648)  
 45X90cm(KA3711)  
 60X120cm(KA4216)  
 90X180cm(KA4217)  
 Packing: Carry bag  
 Feature:Terry surface, tender,  
 ultra-absorbent and dry fast.



BAMBOO TOWEL M 竹碳快干毛巾 **KA4218**  
 BAMBOO TOWEL L 竹碳快干毛巾 **KA4219**

产品信息：  
 材料：90%粘纤，10%涤纶  
 尺寸：45X90cm ( KA4218 )  
 60X120cm ( KA4219 )  
 包装：提袋  
 产品特点：  
 健康除菌，吸湿，快干。

Specification:  
 Material: 90%viscose, 10%polyester  
 Size: 45X90cm(KA4218)  
 60X120cm(KA4219)  
 Packing: carry bag  
 Feature:  
 Anti-bacteria, healthy,  
 super-absorbent and fast-dry.



HIKER MICRO FIBER TOWEL S 便携快干毛巾 **KA3611**  
 HIKER MICRO FIBER TOWEL M 便携快干毛巾 **KA3612**  
 HIKER MICRO FIBER TOWEL L 便携快干毛巾 **KA3613**

产品信息：  
 材料：85%涤纶，15%锦纶  
 30X60cm ( KA3611 )  
 45X90cm ( KA3612 )  
 60X120cm ( KA3613 )  
 包装：提袋  
 产品特点：绒面，柔滑，吸湿，快干。

Specification:  
 Material: 85%polyester, 15%polyamide  
 Size: 30X60cm(KA3611)  
 45X90cm(KA3612)  
 60X120cm(KA3613)  
 Packing: carry bag  
 Feature:Ultrasuede finish.  
 Super-absorbent and dry fast.



HOODED MEMORY FOAM NECK PILLOW  
 带帽记忆绵枕头 **KA7006**

产品信息：  
 材质：涤纶  
 填充：人体工程学记忆棉  
 尺寸：30x30x10cm  
 重量：329 g  
 产品特点：  
 超细摇粒绒面料，  
 记忆棉填充，柔软舒适  
 可折叠，有提袋，方便携带。

Specification:  
 Material: polyester  
 Filling: ergonomic memory foam  
 Product Size: 30x30x10cm  
 Weight: 329g  
 Feature:  
 polyester material and  
 ergonomic memory foam filling,  
 very soft and comfortable  
 Foldable and with carry bag,  
 very easy to carry and store.



### 3 IN 1(PILLOW & SCARF & BLANKET) NECK PILLOW 三合一枕头

#### KA7007

产品信息：  
材质：涤纶  
尺寸：展开：60 x 142cm  
折叠：24 x 24 x 10cm  
重量：190g  
产品特点：  
枕头、围巾、毯子三合一，保证舒适的睡眠；  
舒适的面料；  
折叠设计，方便携带。

Specification:  
Material: polyester  
Size: Stretched: 60x142cm  
Folded: 24x 24x10cm  
Weight: 190g  
Feature:  
Multifunction ( pillow & scarf & blanket )  
for comfortable and supported sleep  
Comfortable fabric  
Foldable design, easy to carry and store.



### SELF INFLATABLE PILLOW 自动充气枕

#### KM3520

产品信息：  
材料：100%聚酯纤维  
气嘴：塑料  
尺寸：40x30x7cm  
包装：30x14cm  
重量：300g  
配件：修补包、涤纶外袋、弹力织带  
产品特点：快速充气放气，重量轻、体积小，方便携带

Specification:  
Material: Polyester  
Valve: Plastic  
Size: 40X30X7cm;  
Packing Size: 30x14cm  
Weight: 300g  
Accessory: Repair kit, integrated straps, stuff sack included.  
Feature: Quick flow valve, light weight.  
Folded packing for easy carrying.



### TRAVEL PILLOW 碎海绵枕头

#### KM3567

产品信息：  
面料：100%聚酯纤维  
气嘴：塑料  
尺寸：50x32x15cm  
包装：30x11cm  
重量：300g  
配件：弹力织带、修补包、牛津布提袋。  
产品特点：快速充气放气，  
重量轻、体积小，方便携带。

Specification:  
Material: Poly-pouch  
Valve: Plastic  
Size: 50x32x15cm  
Packing Size: 30x11cm  
Weight: 300g  
Accessory: Integrated straps,  
repair kit, stuff sack included  
Feature:  
Quick flow valve, light weight, folded packing,  
for easy carrying, stuff sack included.



### NECK PILLOW 颈枕

#### KM3563

产品信息：  
面料：全棉面料，PVC  
规格：44x28CM  
重量：200g  
包装尺寸：15x12.5x3cm  
产品特点：  
全棉布袋，颜色多样，  
可更换，方便清洗，非常舒适。  
方便充气放气。  
适合火车等长途旅行。

Specification:  
Material: Cotton, PVC  
Size: 44x28cm  
Weight: 200g  
Packing Size: 15x12.5x3cm  
Feature:  
Cotton surface, easy to clean,  
inflate and deflate.  
Ideal for train and long time travel.





### 3 TUBE COTTON PILLOW

#### 三管棉布枕头

##### KM3553

产品信息：  
 材料：全棉面料加橡胶  
 规格：38X38cm  
 重量：240g  
 包装尺寸：19X10X2cm  
 产品特点：  
 快速充气放气，  
 耐磨、气密性好，方便携带。

Specification:  
 Material: Rubberized cotton  
 Size: 38X38cm  
 Weight: 240g  
 Packing Size: 19x10x2cm  
 Feature:  
 Easy to inflate and deflate.  
 Durable, airtight prevent  
 coldness & damp proof.  
 Includes emergency repair  
 kit and spare plug.



### COTTON ENVELOPE SLEEPING BAG LINER

#### 纯棉信封型睡袋内胆

##### KA5206

产品信息：  
 材质：棉  
 产品尺寸：(190 + 30) x 86 cm  
 包装尺寸：17 x 10 x 8 cm  
 重量：347g  
 产品特点：  
 折叠小巧，重量轻；  
 手提袋包装；可水洗；  
 面料舒适亲肤。

Specification:  
 Material: cotton  
 Product Size: (190 + 30) x 86 cm  
 Package Size: 17 x 10 x 8 cm  
 Weight: 347g  
 Feature:  
 compact and lightweight;  
 Packed in a carry bag; Washable;  
 Comfortable material to touch your skin.



### COTTON MUMMY SLEEPING BAG LINER

#### 纯棉妈咪型睡袋内胆

##### KA5207

产品信息：  
 材质：棉  
 产品尺寸：241 x 86/56cm  
 包装尺寸：17 x 10 x 8 cm  
 重量：320g  
 产品特点：  
 折叠小巧，重量轻；  
 手提袋包装；可水洗；  
 面料舒适亲肤。

Specification:  
 Material: cotton  
 Product Size: 241x86/56cm  
 Package Size: 17x10x8cm  
 Weight: 320g  
 Feature:  
 compact and lightweight;  
 Packed in a carry bag;  
 Washable;  
 Comfortable material to  
 touch your skin.



### EGYPTIAN COTTON ENVELOPE SLEEPING BAG LINER

#### 埃及棉信封型睡袋内胆

##### KA5208

产品信息：  
 材质：埃及棉  
 产品尺寸：(190 + 30) x 86 cm  
 包装尺寸：17 x 10 x 8 cm  
 重量：268g  
 产品特点：  
 折叠小巧，重量轻；  
 手提袋包装；可水洗；  
 面料生态环保，舒适亲肤。

Specification:  
 Material: Egyptian cotton  
 Product Size: (190 + 30) x 86 cm  
 Package Size: 17 x 10 x 8 cm  
 Weight: 268g  
 Feature:  
 Compact and lightweight;  
 Packed in a carry bag; Washable;  
 Eco and comfortable material to touch your skin.

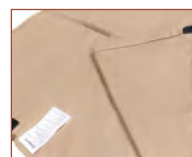

## EGYPTIAN COTTON MUMMY SLEEPING BAG LINER 埃及棉妈咪型睡袋内胆

### KA5209

产品信息：  
材质：埃及棉  
产品尺寸：241 x 86/56cm  
包装尺寸：17 x 10 x 8 cm  
重量：254g  
产品特点：  
折叠小巧，重量轻；  
手提袋包装；可水洗；  
面料生态环保，舒适亲肤。

Specification:  
Material: Egyptian cotton  
Product Size: 241 x 86/56cm  
Package Size: 17 x 10 x 8 cm  
Weight: 254g  
Feature:  
Compact and lightweight;  
Packed in a carry bag; Washable;  
Eco and comfortable material to touch your skin.



## ENVELOPE SLEEPING BAG LINER 信封型睡袋内胆

### KA4033

产品信息：  
材料：聚酯纤维，棉  
产品尺寸：(190+30) × 80cm  
产品特点：  
炎热天气可单独使用，  
配合睡袋使用，  
可延长睡袋使用寿命，  
外形小巧，携带方便，可机洗。

Specification:  
Size: (190+30) × 80cm  
Material: Poly Cotton  
Feature:  
Compact and lightweight.  
Can be used in hot weather.  
Prolong the sleeping bag lifetime.  
Rip stop fabric, stuff sack included.  
Machine washable.



## MUMMY SLEEPING BAG LINER 妈咪型睡袋内胆

### KA4034

产品信息：  
材料：聚酯纤维，棉  
产品尺寸：220 × 80 × 60cm  
产品特点：  
炎热天气可单独使用，  
配合睡袋使用，  
可延长睡袋使用寿命，  
外形小巧，携带方便，可机洗。

Specification:  
Size: 220 × 80 × 60cm  
Material: Poly Cotton  
Feature:  
Compact and lightweight.  
Can be used in hot weather.  
Prolong the sleeping bag lifetime.  
Rip stop fabric, stuff sack included.  
Machine washable.



## DRY BAG IN OXFORD S 牛津布防水袋 KA3681 DRY BAG IN OXFORD M 牛津布防水袋 KA3682 DRY BAG IN OXFORD L 牛津布防水袋 KA3683

产品信息：  
材料：尼龙布加PU涂层  
尺寸：S: 20 × 42cm (15L)  
M: 25 × 57cm (25L)  
L: 25 × 67cm (30L)  
产品特点：  
保持物品干燥整洁，  
理想的户外野营用品。

Specification:  
Material: nylon fabric  
with PU coating  
Size: S: 20 × 42cm  
M: 25 × 57cm  
L: 25 × 67cm  
Feature:  
Keep your belongs dry and clean.  
Ideal for outdoor camping use.



## COMFOOT SHOES HIGH CUT

### 高帮保暖鞋

#### KA7175

产品信息：  
 面料：310T，40D 尼龙防雨布  
 里料：黑色摇粒绒 200g/m<sup>2</sup>  
 填充：中空棉 40g  
 大底：防滑橡胶底  
 外袋：橙色 420D 涤纶格子布 +PU 涂层。  
 产品特点：  
 超轻炫彩面料，耐磨防滑橡胶底，  
 低帮设计穿脱方便，  
 适合居家、旅行、办公、开车、营地使用。

Specification:  
 Material:100% Nylon,40D,PU coating, W/R.  
 Lining:100% Polyester  
 Sole:Rubber  
 Carry bag:100% Polyester  
 Feature:  
 Colorful,rubber sole,low cut,  
 idea for house-waring,travelling,  
 working,driving,camping.



## COMFOOT SHOES LOW CUT

### 低帮保暖鞋

#### KA7176

产品信息：  
 面料：310T，40D 尼龙防雨布  
 里料：黑色摇粒绒 200g/m<sup>2</sup>  
 填充：中空棉 40g  
 大底：防滑橡胶底  
 外袋：橙色 420D 涤纶格子布 +PU 涂层。  
 产品特点：  
 超轻炫彩面料，耐磨防滑橡胶底，  
 低帮设计穿脱方便，  
 适合居家、旅行、办公、开车、营地使用。

Specification:  
 Material:100% Nylon,40D,PU coating, W/R.  
 Lining: 100% Polyester  
 Sole: Rubber  
 Carry bag: 100% Polyester  
 Feature:  
 Colorful, rubber sole, low cut,  
 idea for house-waring, travelling,  
 working, driving, camping.



## COMFOOT SHOES HIGH CUT

### 高帮保暖鞋

#### KA7177

产品信息：  
 面料：310T，40D 尼龙防雨布  
 里料：黑色摇粒绒 200g/m<sup>2</sup>  
 填充：中空棉 40g  
 大底：防滑橡胶底  
 外袋：橙色 420D 涤纶格子布 +PU 涂层。  
 产品特点：  
 超轻炫彩面料，耐磨防滑橡胶底，  
 低帮设计穿脱方便，  
 适合居家、旅行、办公、开车、营地使用。

Specification:  
 Material:100% Nylon,40D,PU coating,W/R.  
 Lining:100% Polyester  
 Sole: Rubber  
 Carry bag:100% Polyester  
 Feature:  
 Colorful,rubber sole,low cut,  
 idea for house-waring,travelling,  
 working,driving,camping.



## COMFOOT SHOES LOW CUT

### 低帮保暖鞋

#### KA7178

产品信息：  
 面料：310T，40D 尼龙防雨布  
 里料：黑色摇粒绒 200g/m<sup>2</sup>  
 填充：中空棉 40g  
 大底：防滑橡胶底  
 外袋：橙色 420D 涤纶格子布 +PU 涂层。  
 产品特点：  
 超轻炫彩面料，耐磨防滑橡胶底，  
 低帮设计穿脱方便，  
 适合居家、旅行、办公、开车、营地使用。

Specification:  
 Material:100% Nylon,40D,PU coating, W/R.  
 Lining:100% Polyester  
 Sole: Rubber  
 Carry bag: 100% Polyester  
 Feature:  
 Colorful, rubber sole, low cut,  
 idea for house-waring, travelling, working,  
 driving, camping.





## STRAW BOTTLE 吸管盖水瓶

### KA1110

产品信息：  
升数:400ml  
瓶口直径：46mm  
瓶身直径：68mm  
瓶身高度：190mm  
材料：  
瓶盖：食品级PP材质+硅胶材质  
提环：一级PE材质  
瓶身：食品级TRITAN材料(美国进口)  
拎手：PA尼龙印花织带  
产品特点：  
TRITAN材料耐高低温（-10~99℃），  
装入100℃热水后请勿直接盖盖；  
所有材料符合食品安全标准；  
所有部位材料使用全新料；  
材料不含双本酚A致癌物质；

Specification:  
Liter: 400ml  
Bottleneck Dia.: 46mm  
Bottle body Dia.: 68mm  
Bottle height: 190mm  
Material:  
Cap: food grade PP+ Silicon  
Rubber ring(around the cap):PE  
Body: Tritan (American Eastman)  
Handle: PA nylon webbing  
Specification:  
Temperature range: -10-99 C,  
do not cover the cap directly  
when water temperature near 100 C;  
Material: all new and environmental;  
totally BPA carcinogenic substance free;



## BOTTLE 平盖水瓶

### KA1111

产品信息：  
升数:400ml  
瓶口直径：46mm  
瓶身直径：68mm  
瓶身高度：210mm  
材料：  
瓶盖：食品级PP材质  
提环：一级PE材质  
瓶身：食品级TRITAN材料(美国进口)  
拎手：食品级PE材质  
产品特点：  
TRITAN材料耐高低温（-10~99℃），  
装入100℃热水后请勿直接盖盖；  
所有材料符合食品安全标准；  
所有部位材料使用全新料；  
材料不含双本酚A致癌物质；

Specification:  
Liter:400ml  
Bottleneck Dia.:46mm  
Bottle body Dia.:68mm  
Bottle height:210mm  
Material:Cap:food grade PP  
Rubber ring(around the cap):PE  
Body:Tritan (American Eastman)  
Handle:PE  
Specification:  
Temperature range:-10-99 C,  
do not cover the cap directly  
when water temperature near 100 C;  
Material: all new and environmental;  
totally BPA carcinogenic substance free;



## BOTTLE 平盖水瓶

### KA1112

产品信息：  
升数:500ml  
瓶口直径：46mm  
瓶身直径：65mm  
瓶身高度：220mm  
材料：  
瓶盖：食品级PP材质  
提环：一级PE材质  
瓶身：食品级TRITAN材料(美国进口)  
拎手：食品级PE材质  
产品特点：  
TRITAN材料耐高低温（-10~99℃），  
装入100℃热水后请勿直接盖盖；  
所有材料符合食品安全标准；  
所有部位材料使用全新料；  
材料不含双本酚A致癌物质；

Specification:  
Liter: 500ml  
Bottleneck Dia.: 46mm  
Bottle body Dia.: 65mm  
Bottle height: 220mm  
Material: Cap: food grade PP  
Rubber ring(around the cap):PE  
Body: Tritan (American Eastman)  
Handle: PE  
Specification:  
Temperature range: -10-99 C,  
do not cover the cap directly  
when water temperature near 100 C;  
Material: all new and environmental;  
totally BPA carcinogenic substance free;



## STRAW BOTTLE 吸嘴盖水瓶

### KA1113

产品信息：  
升数:500ml  
瓶口直径：46mm  
瓶身直径：65mm  
瓶身高度：220mm  
材料：  
瓶盖：食品级PP材质+PC+TPE材质  
提环：一级PE材质  
瓶身：食品级TRITAN材料(美国进口)  
拎手：PA尼龙印花织带  
产品特点：  
TRITAN材料耐高低温（-10~99℃），  
装入100℃热水后请勿直接盖盖；  
所有材料符合食品安全标准；  
所有部位材料使用全新料；  
材料不含双本酚A致癌物质

Specification:  
Liter: 500ml  
Bottleneck Dia.: 46mm  
Bottle body Dia.: 65mm  
Bottle height: 220mm  
Material: Cap: food grade PP+PC+TPE  
Rubber ring(around the cap):PE  
Body: Tritan (American Eastman)  
Handle:PA nylon webbing  
Specification:  
Temperature range: -10-99 C,  
do not cover the cap directly  
when water temperature near 100 C;  
Material: all new and environmental;  
totally BPA carcinogenic substance free;



## BOTTLE 扣盖水瓶

### KA1114

产品信息：  
升数:1000ml  
瓶口直径：55mm  
瓶身直径：75mm  
瓶身高度：270mm  
材料：  
瓶盖：食品级PP材质+TPE+硅胶材质  
提环：一级PE材质  
瓶身：食品级TRITAN材料(美国进口)  
拎手：PA尼龙印花织带  
产品特点：  
TRITAN材料耐高低温（-10~99℃），  
装入100℃热水后请勿直接盖盖；  
所有材料符合食品安全标准；  
所有部位材料使用全新料；  
材料不含双本酚A致癌物质

Specification:  
Liter:1000ml  
Bottleneck Dia.: 55mm  
Bottle body Dia.: 75mm  
Bottle height: 270mm  
Material: Cap: food grade PP+TPE+Silicon  
Rubber ring(around the cap):PE  
Body: Tritan (American Eastman)  
Handle:PA nylon webbing  
Specification:  
Temperature range: -10-99 C,  
in order to prevent thermal expansion and  
contraction, do not cover the cap directly  
when water temperature near 100 C;  
Material: all new and environmental;  
totally BPA carcinogenic substance free;



## BOTTLE 间彩盖水瓶

### KA1115

产品信息：  
升数:1000MLml  
瓶口直径：55mm  
瓶身直径：75mm  
瓶身高度：265mm  
材料：  
瓶盖：食品级PP材质+TPE+硅胶材质  
提环：一级PE材质  
瓶身：食品级TRITAN材料(美国进口)  
拎手：食品级PE材质  
产品特点：  
TRITAN材料耐高低温（-10~99℃），  
装入100℃热水后请勿直接盖盖；  
所有材料符合食品安全标准；  
所有部位材料使用全新料；  
材料不含双本酚A致癌物质

Specification:  
Liter:1000ml  
Bottleneck Dia.:55mm  
Bottle body Dia.:75mm  
Bottle height:265mm  
Material: Cap:food grade PP+TPE+Silicon  
Rubber ring(around the cap):PE  
Body: Tritan (American Eastman)  
Handle:PE  
Specification:  
Temperature range: -10-99 C,  
do not cover the cap directly  
when water temperature near 100 C;  
Material: all new and environmental;  
totally BPA carcinogenic substance free;



## STRAW BOTTLE

## 吸嘴盖水瓶

## KA1123

产品信息：  
升数：650ml  
瓶口直径：50mm  
瓶身直径：77mm  
瓶身高度：240mm  
瓶盖材质：食品级PP+TPE+硅胶  
提环材质：一级PE  
瓶身材质：食品级TRITAN(美国进口)  
拎手：PA尼龙印花织带  
产品特点：  
TRITAN材质耐高低温（-10~99℃）；  
装入100℃热水后请勿直接盖盖；  
所有材料符合食品安全标准；  
材料不含双苯酚A。

Specification:  
Liter: 650ml  
Bottle neck Dia.: 50mm  
Bottle body Dia.: 77mm  
Bottle height: 240mm  
Material:  
cap: food grade PP+ TPE+ Silicone  
Rubber ring (around the cap): PE  
Body: Tritan (American Eastman)  
Handle: PA nylon webbing  
Temperature range: -10~99℃,  
do not cover the cap directly when  
water temperature near 100℃;  
original and environmental material;  
totally BPA free.

BOTTLE  
水瓶

## KA3733

产品信息：  
升数：750ml  
瓶口直径：80mm  
瓶身直径：80mm  
瓶身高度：250mm  
材料：  
瓶盖：食品级PP材质+PC  
瓶身：食品级PCTG材料(美国进口)  
拎手：食品级PE材质  
产品特点：  
TRITAN材料耐高低温（-10~100℃），  
装入100℃热水后请勿直接盖盖；  
所有材料符合食品安全标准；  
所有部位材料使用全新料；  
材料不含双苯酚A致癌物质

Specification:  
Liter: 750ml  
Bottle neck Dia.: 80mm  
Bottle body Dia.: 80mm  
Bottle height: 250mm  
Material: Cap: food grade PP+PC  
Body: PCTG  
Handle: PE  
Specification:  
Temperature range: -10-100℃;  
Material:  
all new and environmental;  
totally BPA carcinogenic  
substance free;

BOTTLE  
水瓶

## KA3734

产品信息：  
升数：1000ml  
瓶口直径：90mm  
瓶身直径：90mm  
瓶身高度：275mm  
材料：  
瓶盖：食品级PP材质+PC  
瓶身：食品级PCTG材料(美国进口)  
拎手：食品级PE材质  
产品特点：  
TRITAN材料耐高低温（-10~100℃），  
装入100℃热水后请勿直接盖盖；  
所有材料符合食品安全标准；  
所有部位材料使用全新料；  
材料不含双苯酚A致癌物质

Specification:  
Liter: 1000ml  
Bottle neck Dia.: 90mm  
Bottle body Dia.: 90mm  
Bottle height: 275mm  
Material: Cap: food grade PP+PC  
Body: PCTG  
Handle: PE  
Specification:  
Temperature range: -10-100℃;  
Material:  
all new and environmental;  
totally BPA carcinogenic  
substance free;



## BOTTLE

## 水瓶

## KA3736

产品信息：  
升数：750ml  
瓶口直径：70mm  
瓶身直径：70mm  
瓶身高度：230mm  
材料：瓶盖：食品级PP材质  
瓶身：食品级PCTG材料(美国进口)  
拎手：食品级PP材质  
产品特点：  
TRITAN材料耐高低温（-10~100℃）；  
所有材料符合食品安全标准；  
所有部位材料使用全新料；  
材料不含双苯酚A致癌物质；

Specification:  
Liter: 750ml  
Bottle neck Dia.: 70mm  
Bottle body Dia.: 70mm  
Bottle height: 230mm  
Material: Cap: food grade PP  
Body: PCTG  
Handle: food grade PP  
Specification:  
Temperature range: -10-100℃;  
Material: all new and environmental;  
totally BPA carcinogenic substance free;



## BOTTLE

## 水瓶

## KA3737

产品信息：  
升数：1000ml  
瓶口直径：55mm  
瓶身直径：75mm  
瓶身高度：270mm  
材料：瓶盖：食品级PP材质+TPE+硅胶材质  
提环：一级PE材质  
瓶身：食品级TRITAN材料(美国进口)  
拎手：PA尼龙印花织带  
产品特点：TRITAN材料耐高低温（-10~99℃），  
装入100℃热水后请勿直接盖盖；  
所有材料符合食品安全标准；  
所有部位材料使用全新料；  
材料不含双苯酚A致癌物质

Specification:  
Liter: 1000ml  
Bottle neck Dia.: 55mm  
Bottle body Dia.: 75mm  
Bottle height: 270mm  
Material: Cap: food grade PP+TPE+Silicon  
Rubber ring (around the cap): PE  
Body: Tritan (American Eastman)  
Handle: PA nylon webbing  
Specification: Temperature range: -10-99℃,  
in order to prevent thermal expansion and  
contraction, do not cover the cap directly  
when water temperature near 100℃;  
Material: all new and environmental;  
totally BPA carcinogenic substance free;



VACUUM FLASK 0.5L 子弹头保温瓶 KA3717  
 VACUUM FLASK 0.75L 子弹头保温瓶 KA3718  
 VACUUM FLASK 1L 子弹头保温瓶 KA3719

产品信息：  
 材料：不锈钢  
 尺寸：0.5L/0.75L/1L  
 产品特点：防漏水，子弹头形状，  
 双层保温层，瓶盖下饮水口处按锁防漏水，  
 轻便不碎，防漏水，  
 理想的室内及户外野营用品。

Specification:  
 Material: stainless steel  
 Size: 0.5L/0.75L/1L  
 Feature: Leak proof, bullet shape,  
 double wall insulation.  
 Plastic cap under stainless steel cover,  
 push-button lock to prevent spills.  
 Light weight, ideal for indoor and  
 outdoor camping use.



VACUUM BOTTLE 带拎手保温壶 750ML KA2742  
 VACUUM BOTTLE 带拎手保温壶 1000ML KA2743

产品描述：  
 升数：750ml/1000ml  
 瓶口直径：53mm/53mm  
 瓶身直径：90mm/90mm  
 瓶身高度：230mm/290mm  
 材料：  
 瓶身：内外双层食品级不锈钢，  
 真空保温层  
 拎手：食品级PP  
 产品特点：方便携带，  
 保温效果极佳。

Specification:  
 Liter: 750ml / 1000ml  
 Bottleneck Dia.: 53mm / 53mm  
 Bottle body Dia.: 90mm / 90mm  
 Bottle height: 230mm / 290mm  
 Material: Body:  
 Food grade stainless steel,  
 vacuum insulating layer  
 Handle: food grade PP  
 Specification: With handle,  
 good heat-insulation  
 effect ideal for outdoor use.



VACUUM POT 1500ML  
 带拎手保温壶 1500ML  
 KA2741

产品描述：  
 升数：1500ml  
 瓶口直径：77mm  
 瓶身直径：110mm  
 瓶身高度：310mm  
 材料：  
 瓶身：内外双层食品级不锈钢，  
 真空保温层  
 拎手：食品级PP  
 产品特点：  
 方便携带，保温效果极佳。

Specification:  
 Liter: 1500ml  
 Bottleneck Dia.: 77mm  
 Bottle body Dia.: 110mm  
 Bottle height: 310mm  
 Material: Body:  
 Food grade stainless steel,  
 vacuum insulating layer  
 Handle: food grade PP  
 Specification: Large capacity  
 and with handle, good heat-insulation  
 effect ideal for outdoor use.



VACUUM POT 真空保温壶 1L KA2728  
 VACUUM POT 真空保温壶 1.5L KA2729

产品信息：  
 材料：不锈钢  
 尺寸：1L/1.5L  
 产品特点：  
 防漏水，双层保温层，瓶盖下饮水口处  
 按锁防漏水，防漏水，带拎手，方便易携，  
 理想的室内及户外野营用品。

Specification:  
 Material: stainless steel  
 Size: 1L/1.5L  
 Feature:  
 Leak proof, double wall insulation.  
 Plastic cap under stainless steel cover,  
 push-button lock to prevent spills.  
 With handle,  
 ideal for indoor and outdoor camping use.





## COLORFUL VOCUUM BOTTLE

### 多彩保温杯

#### KA2751

产品描述：  
升数：400ml  
瓶口直径：48mm  
底部直径：66mm  
瓶身高度：235mm  
瓶身材料：内外双层进口  
食品级18/8不锈钢，真空保温层  
瓶盖材料：进口食品级ABS  
产品特点：  
进口食品级18/8不锈钢，真空保温层，  
保温效果极好；独特的提手设计，  
可以扣在运动或旅行袋的任何位置，方便携带；  
水杯底座可当作喝水杯和储物盒  
使用，存放茶叶、小药丸、参片等。

Specification:  
Liter: 400ml  
Bottleneck Dia.: 48mm  
Bottle bottom Dia.: 66mm  
Bottle height: 235mm  
Body material:  
Stainless steel 18/8  
Cap material: ABS  
18/8 imported food grade stainless steel,  
excellent insulation; special handle design,  
can hung on bags for easy carrying;  
base lid can be used as small cups,  
also can store tea, pills, ginseng tablets.



## DOUBLE COVER STAINLESS STEEL MUG

### 双盖保温杯

#### KA2752

产品描述：  
升数：500ml  
瓶口直径：45mm  
顶部直径：68mm  
底部直径：80mm  
瓶身高度：210mm  
瓶身材料：内外双层18/8不锈钢，真空保温层  
瓶盖材料：PP  
产品特点：内外双层不锈钢18/8，  
真空保温层，保温效果极好；  
独特设计的双杯盖，方便分享。  
适用于办公室生活和户外运动。

Specification:  
Liter: 500ml  
Bottleneck Dia.: 45mm  
Bottle top Dia.: 68mm  
Bottle bottom Dia.: 80mm  
Bottle height: 210mm  
Body material:  
Stainless steel 18/8  
Cap material: PP  
18/8 food grade stainless steel,  
excellent insulation;  
double cover, easy to share.  
Ideal for outdoor sports and office life.



## 8L WATER CARRIER

### 折叠水桶

#### KA3616

产品信息：  
材料：食品级LDPE（无毒）  
容量：8 L  
尺寸：打开：20x23cm  
折叠：20x8cm  
产品特点：  
可调节开关，舒适手柄，  
可压缩，体积小巧，方便携带，  
适合户外烹饪用。

Specification:  
Material: Food Grade LDPE (non-toxic)  
Volume: 8L  
Size: Open: 20x23cm  
Fold: 20x8cm  
Feature:  
Switch on cap with on-off spout.  
Firm handle, Foldable for easy  
storage and carry.  
Ideal for outdoor cooking.



## 15L SQUARE WATER CARRIER

### 方形折叠水桶

#### KA2712

产品信息：  
材料：食品级LDPE（无毒）  
容量：15 L  
尺寸：打开：23x23x23cm  
折叠：23x23x8cm  
产品特点：  
可调节开关，手柄舒适牢固，  
可压缩，体积小巧，  
方便携带，适合户外烹饪用。

Specification:  
Material: Food Grade LDPE (non-toxic)  
Volume: 15L  
Size: Open: 23x23x23cm  
Fold: 23x23x8cm  
Feature:  
Switch on cap with on-off spout.  
Firm handle, Foldable for easy  
storage and carry.  
Ideal for outdoor cooking.



**COMPACT**  
四节铝合金直握登山杖  
**KA4666**

产品信息：  
材料：6061铝合金，EVA手柄  
尺寸：展开：135cm，折叠：58cm  
管径：18/16/14/12mm  
产品净重：254g/根  
产品特点：一对装。  
内含减震系统，有效保护膝盖；  
四节杖收纳更方便；  
精美刻度线，  
特制精美脚套和阻泥托。

Specification:  
Material: Aluminum, EVA handle  
Size: 135/58cm  
Shaft: 18/16/14/12mm  
Weight: 254 g/pc  
2 pcs in Package.  
Anti-shock, 4-section, easily adjustable  
webbing handle strap.



**COMPACT T**  
T把手铝合金四节登山杖  
**KA4667**

产品信息：  
材料：6061铝合金  
尺寸：展开：135cm，折叠：58cm  
管径：18/16/14/12mm  
产品净重：290g/根  
产品特点：内含减震系统，  
有效保护膝盖；  
四节杖收纳更方便；  
软木T把手，舒适吸汗防滑；  
精美的刻度线，  
特制精美脚套和阻泥托。

Specification:  
Material: Aluminum,  
EVA & cork handle  
Size: 135/58cm  
Shaft: 18/16/14/12mm  
Weight: 290 g/pc  
Anti-shock, 4-section, easily  
adjustable webbing handle strap,  
EVA & cork handle.



**LITE PREMIUM**  
四节铝合金直握登山杖  
**KA4668**

产品信息：  
材料：7075铝合金  
尺寸：展开：135cm，折叠：58cm  
管径：18/16/14/12mm  
产品净重：250g/根  
产品特点：一对装。  
金属衬套，使整个手杖更强韧；  
内含减震系统，有效保护膝盖；  
四节杖收纳更方便；  
EVA手柄，舒适吸汗防滑；  
精美的刻度线，  
特制精美脚套和阻泥托。

Specification:  
Material: Aluminum, EVA handle  
Size: 135/58cm  
Shaft: 18/16/14/12mm  
Weight: 250 g/pc  
2 pcs in Package. Anti-shock,  
4-section, easily adjustable  
webbing handle strap,  
EVA handle.



## TRAVELER 旅行登山杖 KA3620

产品信息：  
材料：6061铝合金，PP手柄  
尺寸：展开：135cm，折叠：68cm  
直径：18/16/14mm  
承重（纵向静止）：60KG  
产品特点：防震系统，三节系统，超轻铝合金，收缩方便，橡胶保护套，手柄织带可调节。

Specification:  
Material: Aluminum, PP handle  
Size: 135/68cm  
Shaft: D18/16/14mm  
Weight capacity (vertical & static): 60KG  
Feature:  
Anti-shock, 3-section, light weight.  
Adjustable webbing handle strap.  
Rubber tip protector.



## MULTI-FUNCTION POLE 四节登山杖 KA4622

产品信息：  
材料：铝合金，PP手柄  
尺寸：展开：175cm，折叠：68cm  
直径：D18/16/14/12mm  
承重（纵向静止）：60KG  
产品特点：减震系统，四节系统，超轻铝合金，收缩方便，橡胶保护套，手柄织带可调节，可做帐篷支架，担架使用。

Specification:  
Material: Aluminum, PP handle  
Size: 175/68cm  
Shaft: D18/16/14/12mm  
Weight capacity (vertical & static): 60KG  
Feature:  
Anti-shock, 4-section, light weight.  
Adjustable webbing handle strap.  
Rubber tip protector. Work as stretcher, holding pole for tent.



## FOLDING SPORT POLE 外锁调节三节登山杖 KA4630

产品信息：  
材料：铝合金，EVA手柄  
尺寸：展开：130cm，折叠：53cm  
直径：D14/16/16/16mm  
产品特点：可折叠，易收纳，装入尼龙外袋后方便携带，手柄下端外锁可用于调节长度。

Specification:  
Material: Aluminum, EVA handle  
Size: 130/53cm  
Shaft: D14/16/16/16mm  
Feature: 4-section, length adjustable by the lock; foldable; Adjustable webbing handle strap.  
Rubber tip protector.





## PEDOMETER POLE

### 计步器登山杖

#### KA4632

产品信息：

材料：铝合金，EVA手柄

尺寸：展开：135cm，折叠：68cm

直径：D18/16/14mm

产品特点：

计步器与登山杖一体设计，方便使用，可同时计步和卡路里数，可显示时间；内置膨胀系统调节长度。

Specification:

Material: Aluminum, EVA handle

Size: 135/68cm

Shaft: D18/16/14mm

Feature: 3-section, length adjustable; with pedometer, can count the number of steps and calories, can display time; Adjustable webbing handle strap; Rubber tip protector.



## PHOTO POLE

### 相机支架登山杖

#### KA4633

产品信息：

材料：铝合金，EVA手柄

尺寸：展开：135cm，折叠：68cm

直径：D18/16/14mm

产品特点：

减震系统，三节杖杆，超轻铝合金，收缩方便，橡胶保护套，手柄织带可调节，可做相机支架使用。

Specification:

Material: Aluminum, EVA handle

Size: 135/68cm

Shaft: D18/16/14mm

Feature: Anti-shock; 3-section, length adjustable; Adjustable webbing handle strap; Rubber tip protector. Work as stretcher, holding pole for camera.



**AIR**  
全碳素杆登山杖  
**KA4664**

产品信息：  
材料：全碳素杆  
尺寸：展开：135cm，折叠：66cm  
管径：18/16/14mm  
产品净重：199 g  
产品特点：100%碳素杆，全EVA手柄，最大限度降低手腕自重。3节杖杆，内置膨胀系统，快速调节腕带。

Specification:  
Material: full carbon fiber  
Size: 135/66 cm  
Shaft: 18/16/14mm  
Weight: 199 g  
Features:  
3-section, light weight,  
EVA handle, adjustable webbing  
handle strap, rubber tip protector.



**AIR QUICK**  
全碳素杆外锁登山杖  
**KA4665**

产品信息：  
材料：全碳素杆  
尺寸：展开：135cm，折叠：64cm  
管径：18/16/14mm  
产品净重：206.5 g  
产品特点：100%碳素杆，全EVA手柄，最大限度降低手腕自重。3节杖杆，内置膨胀系统，快速调节腕带。

Specification:  
Material: full carbon fiber  
Size: 135/66 cm  
Shaft: 18/16/14mm  
Weight: 206.5 g  
Features: 3-section, light weight,  
EVA handle, adjustable webbing  
handle strap, rubber tip protector.



**AIR T**  
50%碳素杆登山杖  
**KA4669**

产品信息：  
材料：50%碳素杆  
尺寸：展开：135cm，折叠：65cm  
管径：18/16/14mm  
产品净重：203 g  
特点：纤维杖杆，自带减震功能，轻量强韧；软木T把手，舒适吸汗防滑；精美的刻度线，特制精美脚套和阻泥托。

Specification:  
Material: 50% carbon fiber  
Size: 135/65 cm  
Shaft: 18/16/14mm  
Weight: 203 g  
Features: 3-section,  
easily adjustable  
webbing handle strap,  
EVA & cork handle.



## EXTERNAL LOCK CARBON POLE

### 外锁碳纤维登山杖

#### KA4631

产品信息：  
材料：50%碳纤维，EVA手柄  
尺寸：展开：135cm，折叠：68cm  
直径：D16/14/12mm  
产品净重：227.5 g  
产品特点：  
三节杖杆，收缩方便；  
50%碳纤维，量轻有韧性。  
橡胶保护套，手柄织带可调节。

Specification:  
Material: 50% carbon, EVA handle  
Size: 135/68cm  
Shaft: D16/14/12mm  
Weight: 227.5 g  
Feature: 3-section,  
length adjustable;  
light weight;  
Adjustable webbing  
handle strap.  
Rubber tip protector.



## ULTRA - LIGHT CARBON POLE

### 炫彩碳纤维登山杖

#### KA4662

产品信息：  
材料：50%碳纤维，EVA手柄  
尺寸：展开：135cm，折叠：68cm  
直径：D16.8/14.4/11.6mm  
产品净重：224 g  
产品特点：  
三节杖杆，收缩方便；  
50%碳纤维，量轻有韧性；  
杖尖保护套，手柄织带可调节。

Specification:  
Material: 50% carbon,  
EVA handle  
Size: 135/68cm  
Shaft: D16.8/14.4/11.6mm  
Weight: 224 g  
Feature:  
3-section, length adjustable;  
light weight; Adjustable  
webbing handle strap.  
Rubber tip protector.





## BOTTLE OPENER 开瓶器



红 橙 蓝 绿

**KA8001**

蜥蜴 LIZARD  
尺寸：3.4X6.4 X0.7cm



红 橙 蓝 绿

**KA8002**

企鹅 PENGUIN  
尺寸：4.0X6.0X0.7cm



红 橙 蓝 绿

**KA8003**

海豚 DOLPHIN  
尺寸：2.6X7.8X0.7cm



红 橙 蓝 绿

**KA8004**

鱼骨头 FISHBONE  
尺寸：2.8X6.6X0.7cm



红 橙 蓝 绿

**KA8005**

驼鹿 MOOSE  
尺寸：5.4X5.6X0.7cm



红 橙 蓝 绿

**KA8006**

熊 BEAR  
尺寸：2.75X5.1X0.7cm



红 橙 蓝 绿

**KA8007**

鹦鹉 PARROT  
尺寸：2.5X7.3X0.7cm



红 橙 蓝 绿

**KA8008**

摩托车 MOTORBIKE  
尺寸：6.3X3.3X0.7cm



红 橙 蓝 绿

**KA8009**

滑板 SKATEBOARD  
尺寸：1.5X8.8X1.8cm

## CARABINER 登山扣



红 橙 蓝 绿

**KA8010**

D形带锁登山扣  
D-SHAPE CARABINER  
WITH SCREW LOCK  
尺寸：4.2X7.8cm



红 橙 蓝 绿

**KA8011**

D形登山扣  
D-SHAPE  
CARABINER  
尺寸：4.2X7.8cm



红 橙 蓝 绿

**KA8012**

梨形带锁登山扣  
GOURD-SHAPE  
CARABINER  
WITH SCREW LOCK  
尺寸：3.7X8.0cm



红 橙 蓝 绿

**KA8013**

梨形登山扣  
GOURD-SHAPE  
CARABINER  
尺寸：3.7X8.0cm



红 橙 蓝 绿

**KA8014**

D形钢丝弹杆登山扣  
D-SHAPE WIRE  
POLE CARABINER  
尺寸：4.6X7.3cm



红 橙 蓝 绿

**KA8015**

鱼形登山扣  
FISH CARABINER  
尺寸：4.7X9.5cm



红 橙 蓝 绿

**KA8016**

骨头形登山扣  
BONE CARABINER  
尺寸：5.4X8.6cm



红 橙 蓝 绿

**KA8017**

心形登山扣  
HEART CARABINER  
尺寸：6.4X6.5cm



红 橙 蓝 绿

**KA8018**

S形钢丝登山扣  
S-SHAPE WIRE  
POLE CARABINER  
尺寸：3.1X5.8cm

## LED 灯



红 橙 蓝 绿

**KA8019**

LED 1  
尺寸：4.4X9.0cm



红 橙 蓝 绿

**KA8020**

LED 2  
尺寸：4.1X8.8cm



红 橙 蓝 绿

**KA8021**

LED 3  
尺寸：3.7X6.3cm



红 橙 蓝 绿

**KA8022**

LED小手电  
MINI LED WITH  
CARABINER  
尺寸：1.6X6.3cm



红 橙 蓝 绿

**KA8023**

3 LED手电  
5 LED MINI TORCH  
尺寸：6.8X1.5X1.3cm



红 橙 蓝 绿

**KA8024**

8字环LED  
FIGURE 8  
CARABINER LED  
尺寸：4.2X6.7cm



红 橙 蓝 绿

**KA8025**

跑道形LED  
TRACK LED  
尺寸：2.9X6.3cm



红 橙 蓝 绿

**KA8026**

D形LED  
D-SHAPE LED  
尺寸：7.3X4.2cm



红 橙 蓝 绿

**KA8027**

多功能LED  
MULTI-FUNCTION LED  
尺寸：11X2.4cm

## WHISTLE 口哨



红 橙 蓝 绿

KA8028

细长形口哨  
SLIM WHISTLE  
尺寸：7X0.6cm

红 橙 蓝 绿

KA8029

铝合金口哨  
ALUMINIUM WHISTL  
尺寸：6.7X0.95cm

红 橙 蓝 绿

KA8030

铝合金口哨  
ALUMINIUM WHISTLE  
尺寸：6.3X1.2cm

红 橙 蓝 绿

KA8031

口哨 WHISTLE  
尺寸：7.1X1.5cm

红 橙 蓝 绿

KA8032

应急口哨  
EMERGENCY WHISTLE  
尺寸：7.4X1.2cm

## TOOL 工具



黑

KA8033

多功能锌合金指南针登山扣  
MULTI-FUNCTION ZINC  
COMPASS CARABINER  
尺寸：7X3.1X0.6cm

红 橙 蓝 绿

KA8034

多功能小刀  
MULTI-FUNCTION KNIFE  
尺寸：7.5X3.2cm

红 橙 蓝 绿

KA8035

小折刀  
FOLDED KNIFE  
尺寸：5.7X4.0cm

银

KA8036

多功能小工具  
MULTI-FUNCTION TOOL  
展开尺寸：7.95cm  
折叠尺寸：5.1X3.3X0.7cm

## NEW TOOL 新工具



KA8041

指南针  
尺寸：7X4.6X1.4cm

KA8042

指南球  
尺寸：直径2.85cm

KA8043

温度计  
尺寸：5.1X3.26X0.9cm

KA8044

口哨  
尺寸：6.0X3.4X2.65cm

KA8045

温度计，指南针，水平仪  
尺寸：8.0x6.1x2.1cm



**北京康尔健野旅游用品有限公司**  
KING CAMP & OUTDOOR PRODUCTS CO.,LTD.

北京市朝阳区大郊亭中街2号院华腾国际3号楼7层  
Add: 7th Floor, No.3 Hua Teng International Building, Da Jiao Ting Middle St.,  
ChaoYang District, Beijing 100124, China

Tel: 86-10-67729361  
Fax: 86-10-87951782  
[www.kingcamp.com.cn](http://www.kingcamp.com.cn)